

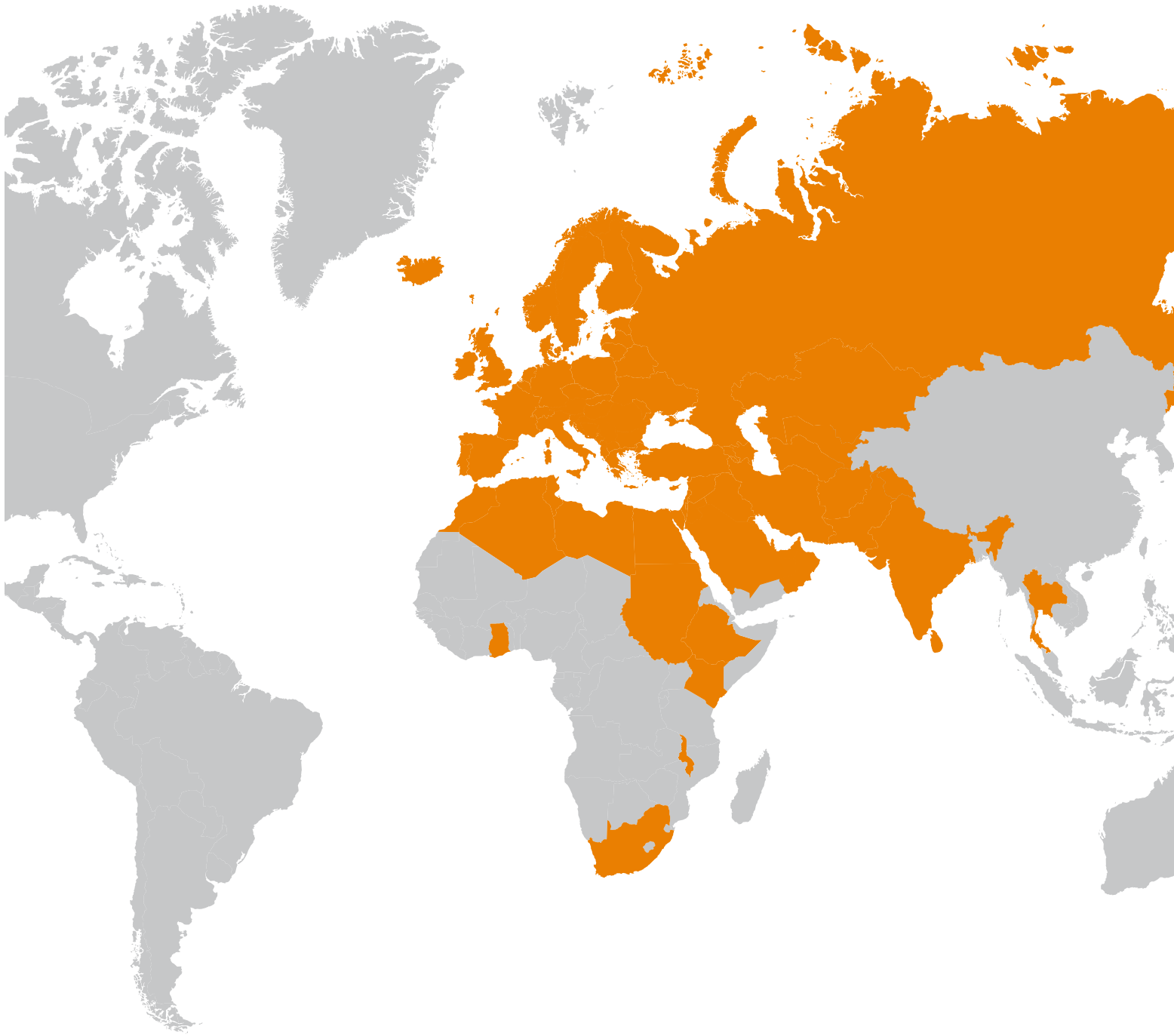

# Product Catalog

Data & Telecommunication  
Solutions and Racks

**CONTEG**



## WE ARE CONTEG

Over the past eighteen years, Conteg has been moving step by step toward the top of the market. We're a leader in supplying complete solutions for data centers, along with all variety of telecommunication cabinets and industrial enclosures. Our representatives can be found in sixty countries, on three continents. We deliver to small businesses, large corporations and complex industrial centers, and can assist you as well. Customer satisfaction is our driving force, though everything begins and ends with trust. Allow us an opportunity to prove that our consistent, personal approach will ensure innovative, effective solutions to suit your every need.





## Conteg by numbers

Established: 1998

International Branches, Showrooms and Representatives: 10

Partners: in 60 countries on 3 continents

Headquarters: Prague, Czech Republic

Production Facilities and Central Warehouse: Pelhrimov, Czech Republic



Headquarters: Prague, Czech Republic



Production Facilities and Central Warehouse:  
Pelhrimov, Czech Republic

# Conteg – Total Solutions for Data Centers

Building a data center is a very complex process, requiring knowledge of other disciplines, cooling and power systems, safety equipment access, monitoring and supervision. Correct layout ensures your satisfaction relating to safety issues, energy consumption, technical availability and countless other areas. The Conteg team has extensive experience in working out systems and proposals, from basic layout to monitoring and traffic control. Our design services include consultation on all sizes of projects, from remote office server rooms to large scale data center enterprises.

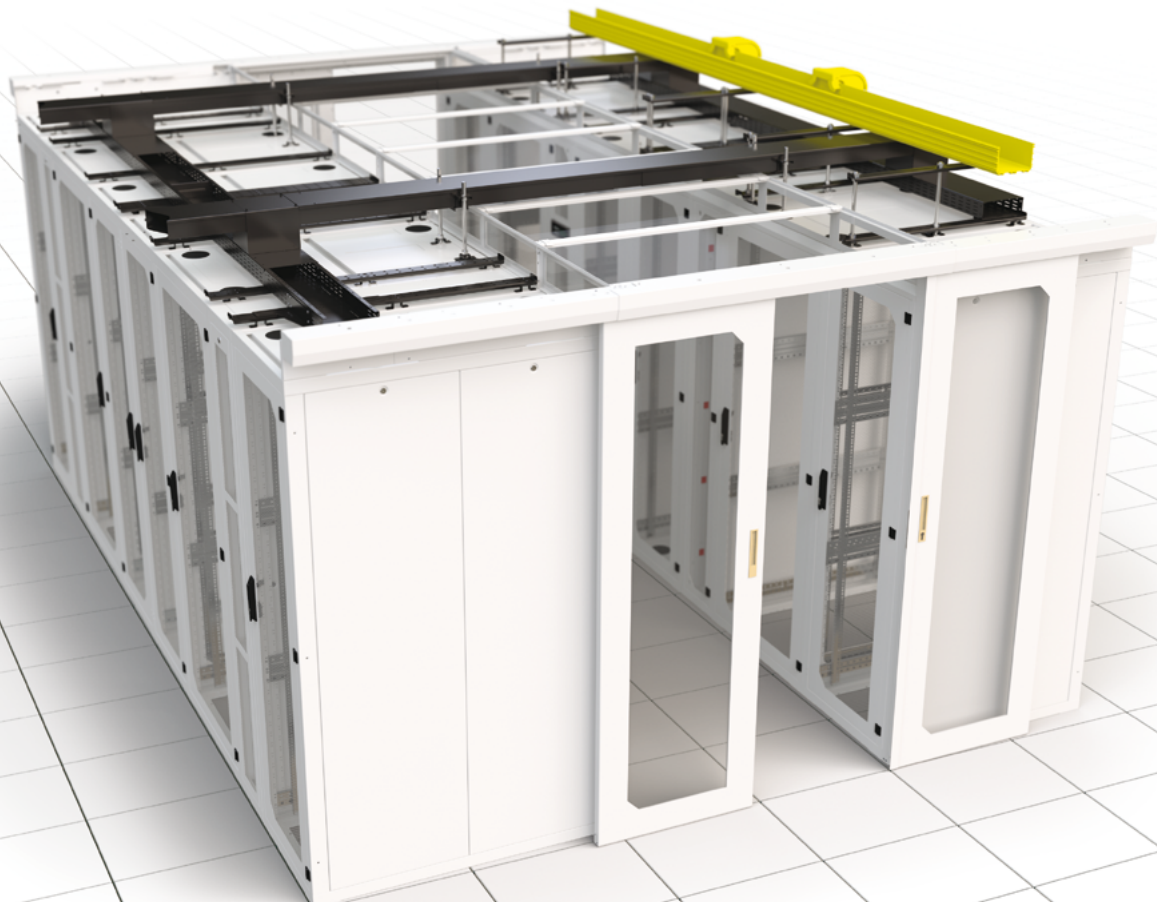

For more information, please contact our sales or technical team at [www.conteg.com/contacts](http://www.conteg.com/contacts)

# Contents

## 01 FREE-STANDING RACKS 4

PREMIUM Rack Series	6
PREMIUM Server RSF	7
PREMIUM Server RSF BYTEline	12
PREMIUM Cabling RDF	14
PREMIUM Housing RSB	18
PREMIUM Rack Series Plates	21
OPTIMAL Rack Series	24
OPTIMAL PC ROP	24
OPTIMAL Cable Management	25
iSEVEN Rack Series	26
iSEVEN Ri7	27
iSEVEN Server	32
iSEVEN Flex RM7	34
iSEVEN Flex Server	38
Open Frames, Space Optimization Sections, Extrusions	41
Open Frames RSG4	41
Open Frames RSG2	42
Open Frames RS	43
Accessories for RS Frames	44
Space Optimization Section	45
19" Extrusions	47

## 02 WALL-MOUNT & SOHO RACKS 48

PREMIUM RUN	51
PREMIUM Split RUD	52
iSEVEN REN	53
SOHO In-Wall ACP	54
SOHO On-Wall ACP	55
SOHO Mini REH 10" RACKS	56
SOHO Mini REH Accessories	57
10" Fiber-optic Splice Box	57

## 03 CABLE MANAGEMENT 58

High Density Wire Management (HDWM)	60
Front Duct System Compatible With Vertical HDWM	61
Vertical HDWM	62
Horizontal HDWM	63
Adjustable Cable Through for Vertical HDWM	64
Optiway Optical Pathway System	65
Main Duct, Joiner, Cross	66
Reducer, Tee, Horizontal Elbow	67
Vertical Inside Elbow, Spillover	68
Vertical Outside Elbow, Trumpet, End Cap, Spillover Support Bracket	69
Threaded Rod Attachment Bracket, Threaded Rod Mounting Brackets	70
Top Duct	71
Top Duct – Cross Connection, Accessories	72
Supporting Brackets	73
Standard Cable Management	74
19" Wire Management Panels with Plastic Brackets, Plastic Cable Brackets	74
19" Wire Management Panels with Plastic Ducts, Wire Management Panels with Metal Brackets, Metal Cable Brackets	75
Vertical Wire Management Panels and Cable Bracket Holders, Vertical Wire Management Panels, Horizontal Cable Tray and Side Cable Management Holders, Side Cable Perforated Panels for A-type Extrusions	76
Cable Basket Trays, Side Cable Perforated Panels, Side Cable Grids	77

## 04 TARGETED COOLING & AIRFLOW MANAGEMENT 78

CoolTeg Plus Cooling Units	81
CoolTeg Plus CW	82
CoolTeg Plus DX	83
CoolTeg Plus XC	85

CoolTop Cooling Units	87
Ventilation Units	88
Fans	89
Lite Ventilation Unit	89
Airflow Management Products	90
Contained Aisle	90
19" Blank and Fast Blank Panels	90
Air Separation Frame	91
Airflow Deflector	91
Chimney	91
19" Vented Panel	92
19" Vented Panel with Brush	92
Side-To-Side Airflow Solution (STS)	93

## 05 COMPLEMENTARY SYSTEMS 94

Rack Monitoring System	96
RAMOS Ultra	97
RAMOS Optima	98
RAMOS Plus	98
RAMOS Mini	98
Accessories	99
Access Control System (ACS)	100
RAMOS Ultra ACS	100
Standalone Electronic Latches	101
CONTEG Pro Server Management (Software)	102
Aegis DCIM	103
Keyboard-Video-Mouse Solutions (KVM/LCD)	104
Local Extinguishing System (LES-RACK)	105
Intelligent & Basic Power Distribution Units	106
Basic Power	106
Intelligent Power – Monitored	107
Intelligent Power – Managed	108
Outlet and Plug Types	109

## 06 ACCESSORIES 110

Shelving	112
19" Fixed Lite Shelves Series DP-PT	112
19" Fixed Shelves Series DP-PO	112
19" Fixed High-Load Shelves Series DP-PZ	112
19" Pull-out Shelves Series DP-PO-V	113
19" Pull-out High Load Shelves Series DP-PZ-V	113
Supporting Rails	113
19" Pull-out Drawer DP-DD	114
19" Pull-out Keyboard Holder Series DP-PV	114
19" Folding Keyboard Holder Series DP-PV	114
21" Adaptors	114
Fiber-optic Products	115
19" Fixed Fiber-Optic Splice Box	115
19" Telescopic Fiber-Optic Splice Box	116
Wall-Mounting Fiber Optic Splice Box	116
Patch Panels	117
19" Panels for 110 Connecting Blocks	117
19" Patch Panels for Keystone Modules	117
19" Patch Panels for LSA-Plus Modules	117
Earthing Bars	118
Cable Clamp Bracket / Earthing Bar for Patch Panel	118
19" Panel with Earthing Bar, Earthing Bar, Earthing Rail	118
Modular Plinths	119
Set of Plinth Corners, Set of Side Panels	119
Plinths for 1200 mm Deep Racks & Space Optimization Sections	120
Mounting & Connecting Kits	121
Others	122
19" Wall-Mounting Holders, Castors & Feet	122
Lighting Units, Cable Protection in Openings	123

## 07 SERVICES 124

Test Center for Data Centers (TC4DC)	127
--------------------------------------	-----

## INDEX 128





01

FREE-STANDING  
RACKS





<b>PREMIUM Rack Series</b>	6
PREMIUM Server RSF	7
PREMIUM Server RSF BYTEline	12
PREMIUM Cabling RDF	14
PREMIUM Housing RSB	18
PREMIUM Rack Series Plates	21
<b>OPTIMAL Rack Series</b>	24
OPTIMAL PC ROP	24
OPTIMAL Cable Management	25
<b>iSEVEN Rack Series</b>	26
iSEVEN Ri7	27
iSEVEN Server	32
iSEVEN Flex RM7	34
iSEVEN Flex Server	38
<b>Open Frames, Space Optimization Sections, Extrusions</b>	41
Open Frames RSG4	41
Open Frames RSG2	42
Open Frames RS	43
Accessories for RS Frames	44
Space Optimization Sections	45
19" Extrusions	47

Comparison	PREMIUM RACK SERIES			
	RSF	RSF BYTEline	RDF	RSB
	Welded-frame	Welded-frame	Welded-frame	Welded-frame
	1.5 and 2 mm sheet steel	1.5 and 2 mm sheet steel	1.5 and 2 mm sheet steel	1.5 and 2 mm sheet steel
	See page 7	See page 12	See page 14	See page 18
<b>Appropriate use</b>				
Server rack	+++	+++	++	+++
Data rack	+++	+++	+++	+
Cable rack	++	++	+++	+
Data centers	+++	+++	+++	+++
<b>Balanced load rating</b>				
Up to 800 kg	yes	yes	yes	yes
Up to 1000 kg	yes	yes	-	yes
Up to 1500 kg	yes	yes	-	yes
Up to 1500 kg on 19" extrusions	yes	yes	-	-
<b>IP rating</b>				
IP20	yes	yes	yes	yes
IP40	yes	-	yes	-
IP54	yes	-	yes	-
<b>Baying</b>				
Side	yes	yes	yes	yes
With special sections	yes	yes	yes	yes
<b>Targeted cooling</b>				
Door perforation 86%	yes	yes	yes	yes
Ventilation units	yes	-	yes	-
CoolTop units	yes	yes	yes	yes
Side-mount CoolTeg units	yes	yes	yes	yes
<b>Cabling</b>				
Changeable internal configuration	yes	yes	yes	yes
Supports HDWM (Cat. 6A and higher)	yes	yes	yes	yes
Supports OptiWay	yes	yes	yes	yes
Supports TopDucts	yes	yes	yes	yes
<b>Size</b>				
27U	yes	-	yes	-
42U	yes	yes	yes	yes
45U	yes	-	yes	yes
48U	yes	-	yes	yes
52U	yes	-	-	-
<b>Colors</b>				
Black RAL 9005	yes	yes	yes	yes
Light gray RAL 7035	yes	yes	yes	yes
<b>Locking system</b>				
Singlepoint	yes	-	yes	yes
Multipoint	yes	yes	yes	-
<b>Security options</b>				
Access control system	yes	yes	yes	yes
Airflow management	yes	yes	yes	yes
Monitoring indoor and outdoor environment	yes	yes	yes	yes

General comparisons of IT rack series; for technical details see appropriate catalog pages.

# PREMIUM SERVER RSF



RSF-42-80/10A

➤ The **PREMIUM Server RSF** rack has been designed as a pure server cabinet for data centers, equipment rooms and network or telecommunication closets. RSF's heavy-duty, all-welded design and up to 1500 kg load rating are perfect for accommodating heavy equipment. RSF is designed to work with both Conteg's cooling and airflow optimization solutions and flexible cable management systems. RSF can be used with many complementary systems (e.g. Intelligent Power PDUs), making your servers safe and secure.

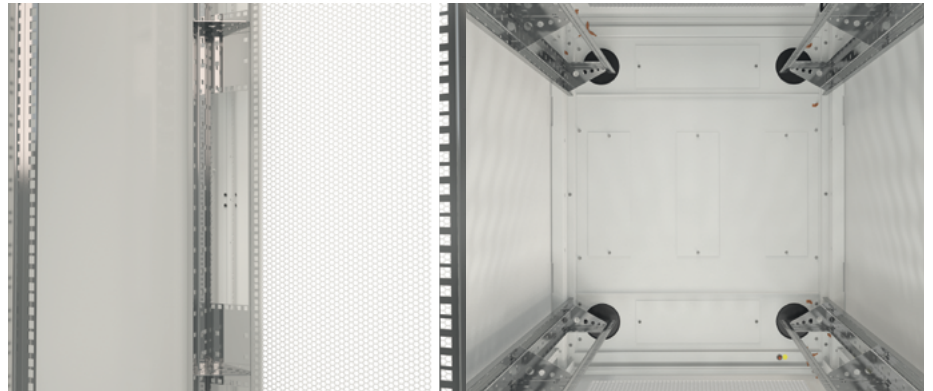

## MAIN ADVANTAGES

- Pure server rack for heavy IT hardware (up to 1500 kg in weight and 52U in height)
- Fully configurable
- Unmatched 86% door perforation ratio decreases server fan power consumption
- Two unique extrusion types allow you to choose the best solution for your application

COLOR SAMPLER:  RAL 9005

 RAL 7035

## DESCRIPTION:

### Sizes

- Height: 27, 42, 45, 48, 52U (52U not available for 800 mm depth)
- Width: 600, 800 mm
- Depth: 800, 1000, 1200 mm (1200 mm not available for 27U)

### Construction

- Welded-frame design
- 1.5 & 2.0 mm sheet steel

### Load rating

- 1500 kg balanced load (1000 kg for 27U only)

### 19" Vertical extrusions

- 2 pairs of sliding 19" vertical A-type (600 or 800 mm) extrusions without horizontal holders (for 800 mm provide additional 24U of installation space – valid for racks 42U and taller), adjustable from inside
- Options: 2 pairs of sliding 19" vertical L-type (600 mm) or P-type (800 mm) extrusions (provide additional 12U of installation space – valid for racks 42U and taller), adjustable from inside. Rear pair of vertical extrusions are divided into 3 parts (according to rack height) for individual settings (according to server depth).

### IP rating

- Standard IP20
- IP40 when solid doors or panels applied
- Options: up to IP54 with multipoint lock only
- A/C-ready – IP54 when A/C unit installed with multipoint lock only

### Colors

- Standard RAL 9005 and 7035

### Front door

- Vented door – perforation rate 86%
- Swivel handle lock – DIN profile, universal key 333, multipoint; optional combination lock or electronic locks, single or multipoint
- Door opening angle 180°
- Easy re-hanging to open on right or left
- Options: glass, steel, perforated, glass with perforation, vertically divided door

### Rear door

- Vented door – perforation rate 86%
- Swivel handle lock – DIN profile, universal key 333, multipoint; optional combination lock or electronic locks, single or multipoint
- Option: replaceable with full range of front doors and panels

### Side panels

- Removable with locks

### Top plate

- Single-piece design, removable
- 4" (100 mm) rounded cable entry in every corner covered by plastic cap
- 300x100 mm cable entries covered with removable blank sheet steel panels

### Bottom plate

- Segmented design, removable
- 4" (100 mm) rounded cable entry in every corner covered by plastic caps
- 300x100 mm cable entries covered with removable blank sheet steel panels

### Feet

- Adjustable feet standard; plinth or plinth with filter optional

### Adaptation

- Can be adapted for installation of 21" equipment (on request, for 800 mm width only)

### Other

- Installable in blocks with DP-DR-UNI (ordered separately)
- GND/earthing kit included

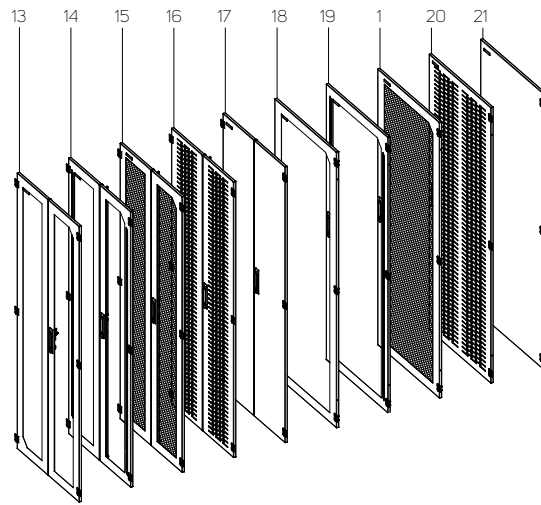
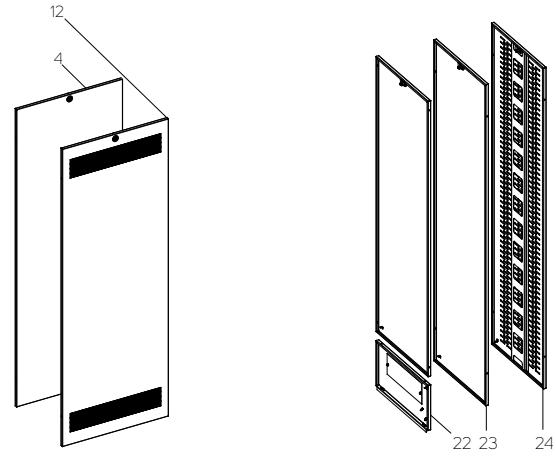
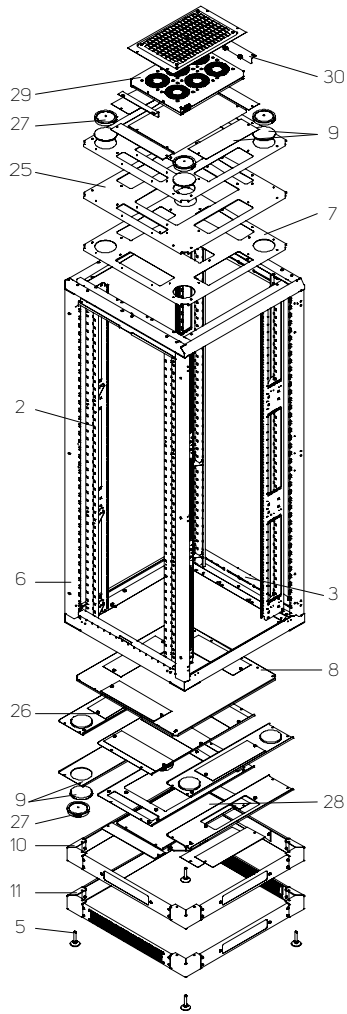

STANDARD CONFIGURATION (short Code only)		OPTIONS	
1	Front and rear vented door 86% with multipoint swivel handle lock	10	Plinth
2	2 pairs A-type 19" sliding extrusions	11	Plinth with filter
3	Vertical extrusion holders	12	1 pair of side panels with perforation
4	1 pair side panels with lock	13	Vertically divided glass door <sup>1,2</sup>
5	Adjustable feet	14	Vertically divided glass door with perforation <sup>1,2</sup>
6	Rack frame	15	Vertically divided vented door 86% <sup>2</sup>
7	Removable F-design top plate with cable entry openings	16	Vertically divided perforated sheet steel door <sup>2</sup>
8	Removable segmented bottom plate set (consists of C and F-design plates; may differ for other rack footprints) with cable entry openings	17	Vertically divided sheet steel door <sup>2</sup>
9	Plastic caps and blank panels for cable entry openings	18	Glass door
-	GND/earthing kit	19	Glass door with side perforation
-	28 mounting kits	20	Perforated sheet steel door
-	FREE BONUS: 2 rounded cable grommets with brush DP-KP-RB4	21	Sheet steel door
		22	Rear panel with module
		23	Rear panel – 1 piece
		24	Rear panel – perforated
		25	Removable B-design top plate with cable entry and ventilation openings
		26	Removable segmented bottom plate set (consists of B and G-design plates; may differ for other rack footprints) with cable entry and ventilation openings
		27	Rounded cable grommet with brush
		28	Blank panels for ventilation openings
		29	Ventilation unit
		30	Connecting kit with ventilation unit filter

<sup>1</sup>Not available for 600 mm wide racks

<sup>2</sup>Requires multipoint lock



TECHNICAL DRAWING

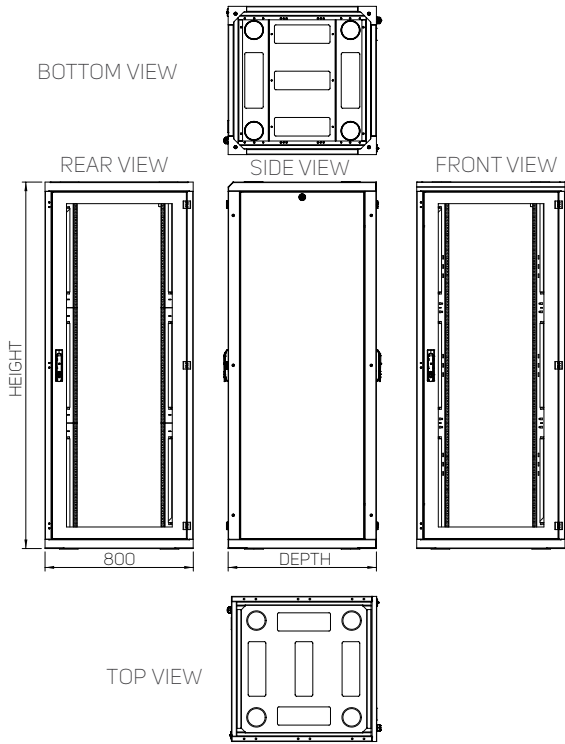

TOP PLATES – F DESIGN

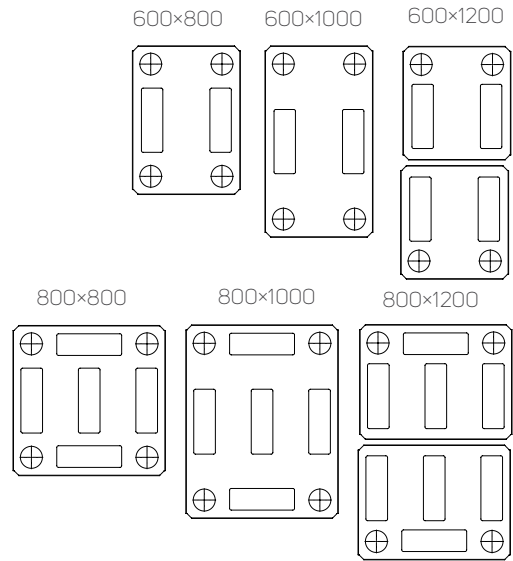

BOTTOM PLATES

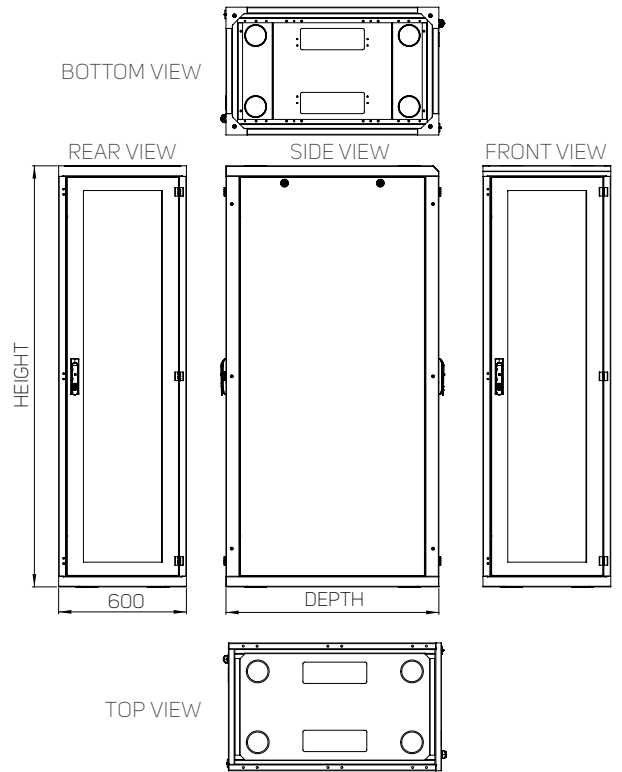
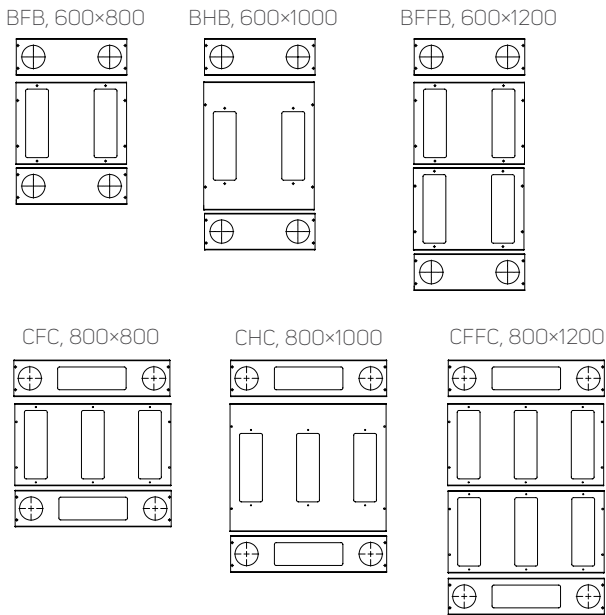

RSF RACKS – CABLE ENTRIES AND VENTILATION OPENINGS

Rack dimensions (width x depth)	Top plate openings		Bottom plate openings	
	300x100 mm	4" (Ø 100 mm)	300x100 mm	4" (Ø 100 mm)
600x800 mm	2x	4x	2x	4x
600x1000 mm	2x	4x	2x	4x
600x1200mm	4x	4x	4x	4x
800x800 mm	5x	4x	5x	4x
800x1000 mm	5x	4x	5x	4x
800x1200 mm	8x	4x	8x	4x

**ORDERING AND SHIPPING INFORMATION:** Configure the rack that meets your requirements. The ordering matrix below will help you create a Code. As soon as you have the Code, please contact your Conteg products distributor. Please note that all RSF RACKS ARE DELIVERED FULLY ASSEMBLED and palletized!

## FOLLOW THE STEPS TO SET UP THE DESIRED RSF RACK CODE!

**R S F - 1. - 2. / 3. 4. - 5. 6. 7. 8. 9. - 10. 11. 12. - 13.**

An example of a correct Code:

**R S F - 48 - 80 / 12 A - W W F W A - 2 E F - H**

1. HEIGHT		
Code	Height (in U)	External height (mm)
27	27	1311
42	42	1978
45	45	2111
48	48	2245
52	52	2423

2. WIDTH	
Code	Width (mm)
60	600
80	800

3. DEPTH		
Code	Depth (mm)	Useful depth (mm)
8	800 <sup>1</sup>	731
10	1000	931
12	1200 <sup>2</sup>	1131

<sup>1</sup> Not available for 52U  
<sup>2</sup> Not available for 27U

4. EXTRUSION			
Code	Front pair	Rear pair	Note
A	A	A	A-type extrusions, non-divided (600 or 800 mm wide) extrusions without horizontal holders (for 800 mm provide additional 24U of installation space – valid for racks 42U and taller) adjustable from inside, blank panels not included
T	L	L divided	L-type extrusions, rear pair divided – for racks 600 mm wide only
U	P	P divided	P-type extrusions, rear pair divided – for racks 800 mm wide only, each extrusion with up to 3 additional 19" vertical positions (27U has 2 positions only), blank panels not included

5. FRONT DOOR	
Code	Note
O	Without door <sup>1</sup>
G	Glass door
S	Sheet steel door
P	Perforated sheet steel door <sup>2</sup>
T	Glass door with side perforation <sup>3</sup>
W	Vented door (perforation rate 86%) <sup>2</sup>
A	Vertically divided glass door <sup>4*</sup>
B	Vertically divided glass door with side perforation <sup>5*</sup>
C	Vertically divided sheet steel door <sup>4</sup>
D	Vertically divided perforated sheet steel door <sup>5</sup>
F	Vertically divided vented door (perforation rate 86%) <sup>5</sup>
	Other

<sup>1</sup> No IP protection  
<sup>2</sup> IP20 max.  
<sup>3</sup> IP30 max.  
<sup>4</sup> Multipoint lock only  
<sup>5</sup> Multipoint lock only, IP20 max.  
<sup>6</sup> Multipoint lock only, IP30 max.  
<sup>\*</sup> Options apply for RSF 800 only

6. FRONT DOOR LOCK	
Code	Note
V	Swivel handle, DIN profile, universal key 333
W	Swivel handle, DIN profile, universal key 333, multipoint
G	Swivel handle with combination lock, individual key
H	Swivel handle with combination lock, individual key, multipoint
1	Electronic door lock with profile half cylinder, cable 4 m
2	Electronic door lock with profile half cylinder and built-in card reader (EM&HID Prox format 125 kHz), 4.5 m cables included
3	Electronic door lock with profile half cylinder, cable 4m, multipoint
4	Electronic door lock with profile half cylinder and built-in card reader (EM&HID Prox format 125 kHz), 4.5 m cables included, multipoint
	Other

7. REAR DOOR / PANEL	
Code	Note
O	Without panel/door <sup>1</sup>
G	Glass door
S	Sheet steel door
P	Perforated sheet steel door <sup>2</sup>
T	Glass door with side perforation <sup>3</sup>
W	Vented door (perforation rate 86%) <sup>2</sup>
A	Vertically divided glass door <sup>4*</sup>
B	Vertically divided glass door with side perforation <sup>5*</sup>
C	Vertically divided sheet steel door <sup>4</sup>
D	Vertically divided perforated sheet steel door <sup>5</sup>
F	Vertically divided vented door (perforation rate 86%) <sup>2</sup>
Y	Rear panel – single piece <sup>3,7</sup>
R	Rear panel – divided, with cable entry <sup>7</sup>
Z	Perforated rear panel – single piece <sup>8</sup>
	Other

<sup>1</sup> No IP protection  
<sup>2</sup> IP20 max.  
<sup>3</sup> IP30 max.  
<sup>4</sup> Multipoint lock only  
<sup>5</sup> Multipoint lock only, IP20 max.  
<sup>6</sup> Multipoint lock only, IP30 max.  
<sup>7</sup> Lock code U or X only  
<sup>8</sup> Lock code U or X only, IP20 max.  
<sup>\*</sup> Options apply for RSF800 only

8. REAR DOOR / PANEL LOCK	
Code	Options
V	Swivel handle, DIN profile, universal key 333
W	Swivel handle, DIN profile, universal key 333, multipoint
G	Swivel handle with combination lock, individual key
H	Swivel handle with combination lock, individual key, multipoint
1	Electronic door lock with profile half cylinder, cable 4 m
2	Electronic door lock with profile half cylinder and built-in card reader (EM&HID Prox format 125 kHz), 4.5 m cables included
3	Electronic door lock with profile half cylinder, cable 4 m, multipoint
4	Electronic door lock with profile half cylinder and built-in card reader (EM&HID Prox format 125 kHz), 4.5 m cables included, multipoint
U	Lock for rear panel, universal key
X	Lock for rear panel, keyed different
	Other

9. SIDE PANELS (BOTH SIDES)*	
Code	Note
O	No side panels
A	2 side panels, sheet steel, universal key
B	1 side panel, sheet steel, universal key
C	2 side panels, sheet steel, individual key
D	1 side panel, sheet steel, individual key
E	2 side panels, sheet steel with perforation, universal key
F	1 side panel, sheet steel with perforation, universal key
G	2 side panels, sheet steel with perforation, individual key
H	1 side panel, sheet steel with perforation, individual key
	Other

\* Open side/sides results in no IP protection; side panels with perforation result in IP20 max protection rating.

10. IP RATING <sup>1</sup>	
Code	Note
O	IP00
2	IP20
3	IP30
4	IP40
5	IP54 <sup>3</sup>
A	A/C ready <sup>2,3</sup>

<sup>1</sup> According to EN 60529  
<sup>2</sup> Ready for A/C unit installation; recommended when cooling planned or required; IP54 when A/C unit installed according to instructions  
<sup>3</sup> Multipoint lock only

11. PLATES <sup>1</sup>			
Code	Top Plate	Bottom plate	Note
A	P	X	Top and bottom single piece plates required for IP54
C	no top	X	Open top – for A/C-ready option (table 10)
E	F	XXX/XXXX <sup>2</sup>	Standard – one piece top plate, segmented bottom plate
F	F	no bottom <sup>3</sup>	Open bottom – ready for installation on raised floor or plinth
X	no top <sup>3</sup>	no bottom <sup>3</sup>	Open top and bottom, for individual plates go to page 21

<sup>1</sup> See pg. 21 for more information  
<sup>2</sup> 600×800: BFB, 600×1000: BHB, 600×1200: BFFB, 800×800: CFC, 800×1000: CHC, 800×1200: CFFC  
<sup>3</sup> Open top or bottom results in no IP protection, unless otherwise stated

12. LOAD RATING		
Code	Load rate (kg)	Note
A	1000	27U only
F	1500	Balanced load

13. COLOR	
Code	Note
B	RAL 7035 (light gray)
H	RAL 9005 (black)

Configure IT rack on-line

www.conteg.com/configurators

## RSF RACKS – TECHNICAL DATA AND DIMENSIONS

Code	H (in U)	Load rating (kg)	Dimensions (mm)				Dimensions incl. packing (mm)			Gross weight (kg)
			H *	W	D	Useful depth	H	W	D	
RSF-27-60/8A	27	1000	1311	600	800	731	1500	640	840	85
RSF-42-60/8A	42	1500	1978	600	800	731	2160	640	840	112
RSF-45-60/8A	45	1500	2111	600	800	731	2290	640	840	119
RSF-48-60/8A	48	1500	2245	600	800	731	2430	640	840	123
RSF-27-60/10A	27	1000	1311	600	1000	931	1500	640	1040	109
RSF-42-60/10A	42	1500	1978	600	1000	931	2160	640	1040	135
RSF-45-60/10A	45	1500	2111	600	1000	931	2290	640	1040	142
RSF-48-60/10A	48	1500	2245	600	1000	931	2430	640	1040	148
RSF-52-60/10A	52	1500	2423	600	1000	931	2608	640	1040	156
RSF-42-60/12A	42	1500	1978	600	1200	1131	2160	640	1240	149
RSF-45-60/12A	45	1500	2111	600	1200	1131	2290	640	1240	170
RSF-48-60/12A	48	1500	2245	600	1200	1131	2430	640	1240	178
RSF-52-60/12A	52	1500	2423	600	1200	1131	2608	640	1240	189
RSF-27-80/8A	27	1000	1311	800	800	731	1500	840	840	100
RSF-42-80/8A	42	1500	1978	800	800	731	2160	840	840	134
RSF-45-80/8A	45	1500	2111	800	800	731	2290	840	840	141
RSF-48-80/8A	48	1500	2245	800	800	731	2430	840	840	147
RSF-27-80/10A	27	1000	1311	800	1000	931	1500	840	1040	124
RSF-42-80/10A	42	1500	1978	800	1000	931	2160	840	1040	157
RSF-45-80/10A	45	1500	2111	800	1000	931	2290	840	1040	165
RSF-48-80/10A	48	1500	2245	800	1000	931	2430	840	1040	173
RSF-52-80/10A	52	1500	2423	800	1000	931	2608	840	1040	184
RSF-42-80/12A	42	1500	1978	800	1200	1131	2160	840	1240	175
RSF-45-80/12A	45	1500	2111	800	1200	1131	2290	840	1240	198
RSF-48-80/12A	48	1500	2245	800	1200	1131	2430	840	1240	208
RSF-52-80/12A	52	1500	2423	800	1200	1131	2608	840	1240	220

\* Height in mm without feet; for feet add 16–45 mm

## Recommended accessories



### CoolTeg Plus Cooling Units

More information [on page 81](#)



### High Density Wire Management

More information [on page 60](#)



### Intelligent Power – Monitored

More information [on page 107](#)

# PREMIUM SERVER RSF BYTEline

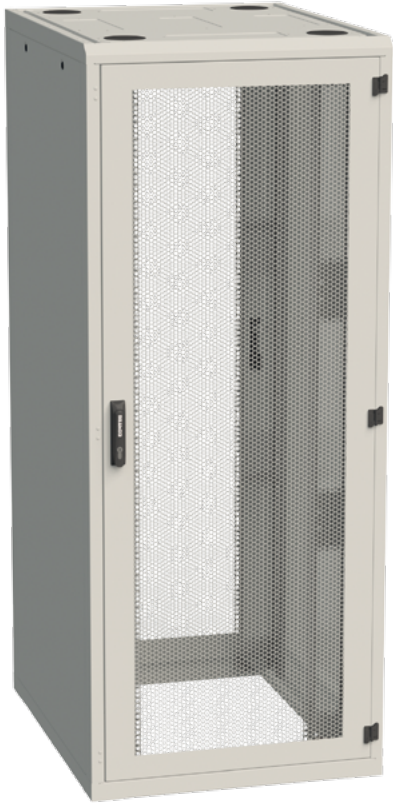

RSF-42-80/100-BLA2

➤ The **PREMIUM Server RSF BYTEline** rack is designed as a dedicated server cabinet for data centers, equipment rooms and network or telecommunication closets. The RSF's heavy-duty, all-welded design and 1500 kg load rating make it ideal for accommodating heavy equipment within a standard rack footprint. 19" RSF server racks also offer top-of-the-line cabling support, with unbeatable access.



## MAIN ADVANTAGES

- All-features-included server rack
- Unmatched 86% door perforation ratio decreases server fan power consumption
- Advanced door design
- Dedicated server design
- Tailored for typical data center projects with hot/cold aisle or contained aisle layouts
- Safety Lift-Off Hinge for tool-less door assembly/disassembly
- Fully compatible with Zero U (0U) PDUs

COLOR SAMPLER:  RAL 9005

 RAL 7035

## DESCRIPTION:

### Sizes

- Height: 42U
- Width: 600, 800 mm
- Depth: 1000, 1200 mm

### Construction

- Welded-frame design
- 1.5 & 2.0 mm sheet steel

### Load rating

- 1500 kg balanced load
- 2 pairs of sliding 19" vertical A-type (600 or 800 mm) extrusions without horizontal holders (for 800 mm provide additional 24U of installation space), adjustable from inside

### IP rating

- Standard IP00

### Colors

- Standard RAL 9005 and 7035

### Front door

- Vented door – perforation rate 86%
- Swivel handle lock – DIN profile, universal key 333, multipoint
- Door opening angle 180°
- Easy re-hanging to open on right or left

### Rear door

- Vented door – perforation rate 86%
- Swivel handle lock – DIN profile, universal key 333, multipoint

### Side panels

- Removable with locks or without side panels

### Top plate

- Single-piece design, removable

- 4" (100 mm) rounded cable entry in every corner covered by plastic cap
- 300x100 mm cable entries covered with removable blank sheet steel panels

### Bottom plate

- No bottom plate

### Feet

- Adjustable feet standard

### Adaptation

- Adaptable for installation of 21" equipment (upon request, for 800 mm width only)

### Other

- Installable in blocks with DP-DR-UNI (ordered separately)
- GND/earthing kit included



**ORDERING INFORMATION FOR RSF BYTEline:** The configurations presented below cannot be changed. Please note that all RSF BYTEline RACKS ARE DELIVERED FULLY ASSEMBLED and palletized!

## RSF BYTEline – DIMENSIONS AND FEATURES

Code	H (in U)	Dimensions (mm)		Front door	Rear door			Side panels		Extrusions	
		W	D	Vented door	Vented door	Vertically divided vented door	Two side panels	Without	A-type	A-type with additional 12×2U	
RSF-42-60/100-BLA1-X	42	600	1000	yes	yes	–	yes	–	yes	–	
RSF-42-60/100-BLA4-X	42	600	1000	yes	yes	–	–	yes	yes	–	
RSF-42-60/100-BLA7-X	42	600	1000	yes	–	yes	yes	–	yes	–	
RSF-42-60/120-BLA8-X	42	600	1200	yes	–	yes	yes	–	yes	–	
RSF-42-60/100-BLA10-X	42	600	1000	yes	–	yes	–	yes	yes	–	
RSF-42-60/120-BLA11-X	42	600	1200	yes	–	yes	–	yes	yes	–	
RSF-42-80/100-BLA2-X	42	800	1000	yes	yes	–	yes	–	–	yes	
RSF-42-80/100-BLA3-X	42	800	1000	yes	–	yes	yes	–	–	yes	
RSF-42-80/100-BLA5-X	42	800	1000	yes	yes	–	–	yes	–	yes	
RSF-42-80/100-BLA6-X	42	800	1000	yes	–	yes	–	yes	–	yes	
RSF-42-80/120-BLA9-X	42	800	1200	yes	–	yes	yes	–	–	yes	
RSF-42-80/120-BLA12-X	42	800	1200	yes	–	yes	–	yes	–	yes	

Substitute X with desired color: B – RAL 7035 (light gray) or H – RAL 9005 (black). Please note that RSF-BYTEline series differs from standard RSF rack configurations.

## Recommended accessories



### Air separation frame

More information [on page 91](#)



### RAMOS Ultra

More information [on page 97](#)



### 19" blank and fast blank panels

More information [on page 90](#)

# PREMIUM CABLING RDF



➤ The **PREMIUM Cabling RDF** rack is designed as a pure cabling cabinet for data centers, equipment rooms and network or telecommunication closets. RDF racks installed with advanced cabling systems (such as High Density Wire Management, OptiWay and Top Ducts), provide the best possible support and care.

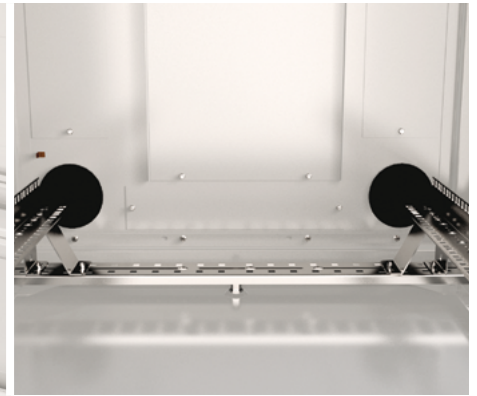

## MAIN ADVANTAGES

- All-purpose rack designed for cabling applications with load up to 800 kg
- Fully configurable
- Compatible with all cable management systems – OptiWay, High Density Wire Management, Top Ducts

COLOR SAMPLER:  RAL 9005

 RAL 7035

RDF-42-80/80

## DESCRIPTION:

### Sizes

- Height: 27, 42, 45, 48U
- Width: 800 mm
- Depth: 800, 1000, 1200 mm (1200 mm not available for 27U)

### Construction

- Welded-frame design
- 1.5 & 2.0 mm sheet steel

### Load rating

- 800 kg balanced load (for 27U 400 kg only)

### 19" vertical extrusions

- 2 pairs of sliding 19" extrusions, adjustable from inside

### IP rating

- Standard IP40
- Optional IP54 (with multipoint lock only)
- IP20 with perforated or vented doors
- A/C ready – IP54 when A/C unit installed with multipoint lock

### Colors

- Standard RAL 7035 and 9005

### Front door

- Tinted security glass door

- Swivel handle lock – DIN profile, universal key 333, multipoint; optional combination lock or electronic locks; single or multipoint
- Door opening angle 180°
- Easy re-hanging to open on right or left
- Optional steel, vented, perforated, glass with perforation, vertically divided door

### Rear door

- Sheet steel door
- Swivel handle lock – DIN profile, universal key 333, multipoint; optional combination lock or electronic locks, single or multipoint
- Can be replaced by a full range of front door and panel options

### Side panels

- Removable with locks

### Top plate

- Single-piece design, removable
- 4" (100 mm) rounded cable entry in every corner covered by plastic cap
- 300×100 mm cable entries covered with removable blank sheet steel panels
- 300×50 mm cable entries covered with removable blank sheet steel panels

- 420×280 mm ventilation opening(s) covered with removable blank sheet steel panels allow for installation of 6-fan ventilation unit(s) (800 mm and 1200 mm deep racks only)
- 420×440 mm ventilation opening covered with removable blank sheet steel panels allow for installation of 9-fan ventilation unit (1000 mm deep racks only)

### Bottom plate

- Segmented design, removable
- 4" (100 mm) rounded cable entry in every corner covered by plastic caps
- 300×100 mm cable entries covered with removable blank sheet steel panels

### Feet

- Adjustable feet standard; castors, lockable castors, plinth or plinth with filter options

### Adaptation

- Adaptable for installation of 21" equipment

### Other

- Installable in blocks with DP-DR-UNI (ordered separately)
- GND/earthing kit included

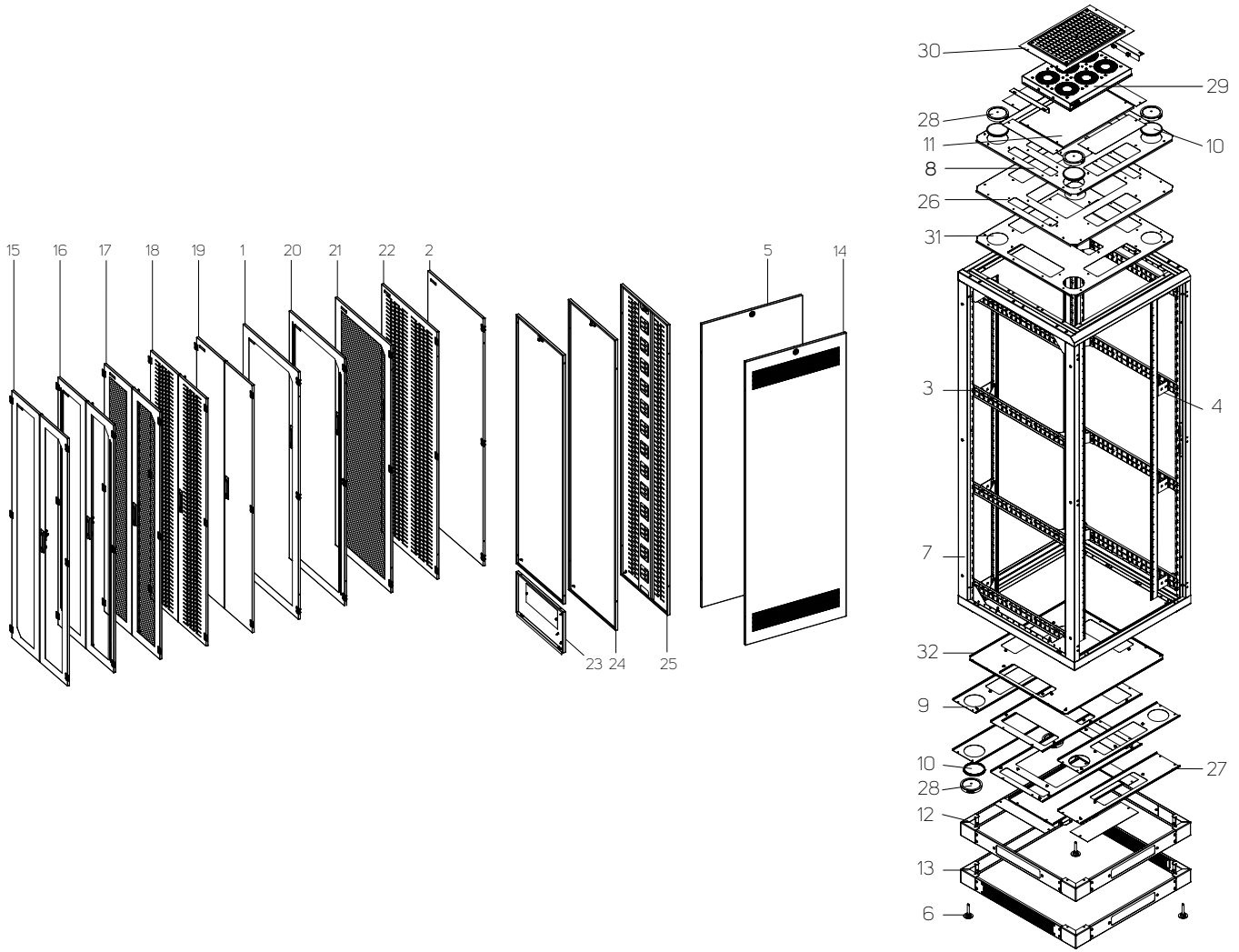

STANDARD CONFIGURATION (short Code only)		OPTIONS	
1	Front glass door with swivel handle lock	13	Plinth with filter
2	Rear sheet steel door with swivel handle lock	15	Vertically divided glass door*
3	2 pairs of 19" sliding extrusions	16	Vertically divided glass door with perforation*
4	Vertical extrusion holders	17	Vertically divided vented door 86%
5	1 pair of side panels with lock	18	Vertically divided perforated sheet steel door*
6	Adjustable feet	19	Vertically divided sheet steel door*
7	Rack frame	20	Glass door with side perforation
8	Removable I-design top plate with cable entry and ventilation openings	21	Vented door 86%
9	Removable segmented bottom plate set (consists of C and F-design plates; may differ for other rack footprints) with cable entry openings	22	Perforated sheet steel door
10	Plastic caps and blank panels for cable entry openings	23	Rear panel with module
11	Blank panel for ventilation opening	24	Rear panel – 1 piece
12	Plinth	25	Rear panel – perforated
14	1 pair of side panels with perforation	26	Removable B-design top plate with cable entry and ventilation openings
-	GND/earthing kit	27	Removable segmented bottom plate set (consists of B and G-design plates; may differ for other rack footprints) with cable entry and ventilation openings
-	28 mounting kits	28	Rounded cable grommet with brush
-	BONUS: 2 rounded cable grommets with free DP-KP-RB4 brush	29	Ventilation unit
		30	Connecting kit with filter for ventilation unit
		31	Removable F-design top plate with cable entry and ventilation openings
		32	Removable X-design bottom plate with cable entry openings

\* Requires multipoint lock

TOP PLATES – I DESIGN

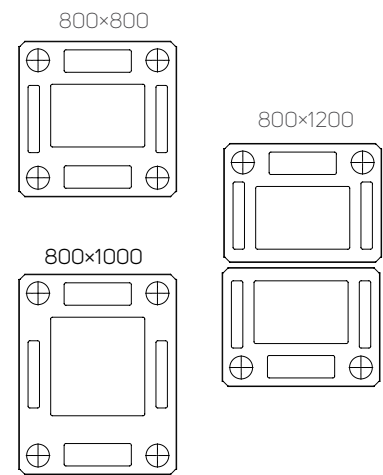
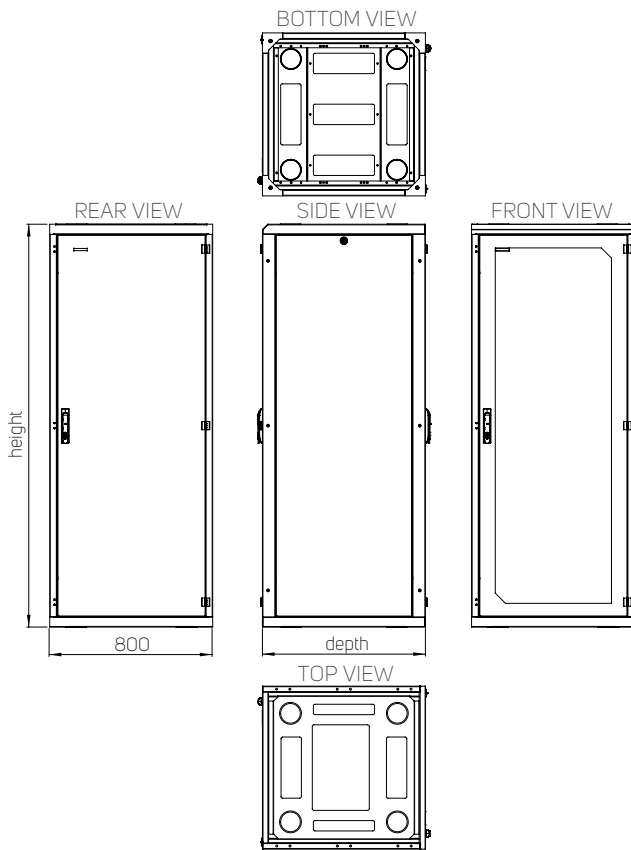

BOTTOM PLATES

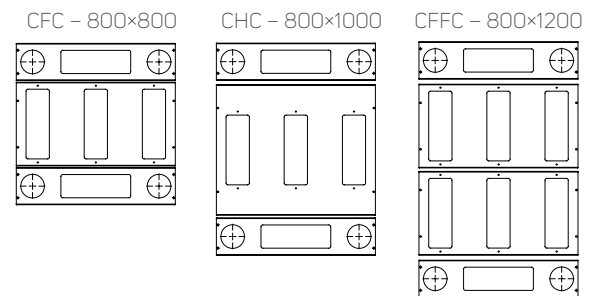

RDF RACKS – CABLE ENTRIES AND VENTILATION OPENINGS

Rack dimensions (width × depth)	Top plate openings					Bottom plate openings	
	300×100 mm	300×50 mm	4" (Ø 100 mm)	420×280 mm	420×440 mm	300×100 mm	4" (Ø 100 mm)
800×800 mm	2×	2×	4×	1×	–	5×	4×
800×1000 mm	2×	2×	4×	–	1×	5×	4×
800×1200 mm	2×	4×	4×	2×	–	8×	4×

RDF RACKS – TECHNICAL DATA AND DIMENSIONS

Code	H (in U)	Load rating (kg)	Dimensions (mm)				Dimensions incl. packing (mm)			Gross weight (kg)
			H*	W	D	Useful depth	H	W	D	
RDF-27-80/80	27	400	1311	800	800	731	1500	840	840	100
RDF-42-80/80	42	800	1978	800	800	731	2160	840	840	134
RDF-45-80/80	45	800	2111	800	800	731	2290	840	840	141
RDF-48-80/80	48	800	2245	800	800	731	2430	840	840	147
RDF-27-80/100	27	400	1311	800	1000	931	1500	840	1040	124
RDF-42-80/100	42	800	1978	800	1000	931	2160	840	1040	157
RDF-45-80/100	45	800	2111	800	1000	931	2290	840	1040	165
RDF-48-80/100	48	800	2245	800	1000	931	2430	840	1040	173
RDF-42-80/120	42	800	1978	800	1200	1131	2160	840	1240	175
RDF-45-80/120	45	800	2111	800	1200	1131	2290	840	1240	198
RDF-48-80/120	48	800	2245	800	1200	1131	2430	840	1240	208

\* Height in mm without feet; for feet add 16–45 mm



**ORDERING AND SHIPPING INFORMATION:** Configure the rack that meets your requirements. The ordering matrix below will help you create a Code. As soon as you have the Code, please contact your Conteg products distributor. Please note that all RDF RACKS ARE DELIVERED FULLY ASSEMBLED and palletized!

## FOLLOW THE STEPS TO SET UP THE DESIRED RDF RACK CODE!

**R D F - 1. - 2. / 3. 4. - 5. 6. 7. 8. 9. - 10. 11. 12. - 13.**

An example of a correct Code:

**R D F - 45 - 80 / 8 0 - A W S W A - A C 5 - H**

1. HEIGHT		
Code	Height (in U)	External height (mm)
27	27	1311
42	42	1978
45	45	2111
48	48	2245

2. WIDTH	
Code	Width (mm)
80	800

3. DEPTH		
Code	Depth (mm)	Useful depth (mm)
8	800	731
10	1000	931
12	1200	1131

4. EXTRUSIONS			
Code	Front pair	Rear pair	Note
0	L	L	L-type undivided extrusions

5. FRONT DOOR	
Code	Note
O	Without door <sup>1</sup>
G	Glass door
S	Sheet steel door
P	Perforated sheet steel door <sup>2</sup>
T	Glass door with side perforation <sup>3</sup>
W	Vented door (perforation rate 86%) <sup>2</sup>
A	Vertically divided glass door <sup>4</sup>
B	Vertically divided glass door with side perforation <sup>6</sup>
C	Vertically divided sheet steel door <sup>4</sup>
D	Vertically divided perforated sheet steel door <sup>5</sup>
F	Vertically divided vented door (perforation rate 86%) <sup>2</sup>
	Other

6. FRONT DOOR LOCK	
Code	Options
V	Swivel handle, DIN profile, universal key 333
W	Swivel handle, DIN profile, universal key 333, multipoint
G	Swivel handle with combination lock, individual key
H	Swivel handle with combination lock, individual key, multipoint
1	Electronic door lock with profile half cylinder, cable 4 m
2	Electronic door lock with profile half cylinder and built-in card reader (EM&HID Prox format 125 kHz), 4.5 m cables included
3	Electronic door lock with profile half cylinder, cable 4 m, multipoint
4	Electronic door lock with profile half cylinder and built-in card reader (EM&HID Prox format 125 kHz), 4.5 m cables included, multipoint
	Other

7. REAR DOOR / PANEL	
Code	Note
O	Without panel/door <sup>1</sup>
G	Glass door
S	Sheet steel door
P	Perforated sheet steel door <sup>2</sup>
T	Glass door with side perforation <sup>3</sup>
W	Vented door (perforation rate 86%) <sup>2</sup>
A	Vertically divided glass door <sup>4</sup>
B	Vertically divided glass door with side perforation <sup>6</sup>
C	Vertically divided sheet steel door <sup>4</sup>
D	Vertically divided perforated sheet steel door <sup>5</sup>
F	Vertically divided vented door (perforation rate 86%) <sup>2</sup>
Y	Rear panel – single piece <sup>3,7</sup>
R	Rear panel – divided, with cable entry <sup>7</sup>
Z	Perforated rear panel – single piece <sup>8</sup>
	Other

8. REAR DOOR / PANEL LOCK	
Code	Options
V	Swivel handle, DIN profile, universal key 333
W	Swivel handle, DIN profile, universal key 333, multipoint
G	Swivel handle with combination lock, individual key
H	Swivel handle with combination lock, individual key, multipoint
1	Electronic door lock with profile half cylinder, cable 4 m
2	Electronic door lock with profile half cylinder and built-in card reader (EM&HID Prox format 125 kHz), 4.5 m cables included
3	Electronic door lock with profile half cylinder, cable 4 m, multipoint
4	Electronic door lock with profile half cylinder and built-in card reader (EM&HID Prox format 125 kHz), 4.5 m cables included, multipoint
U	Lock for rear panel, universal key
X	Lock for rear panel, keyed different
	Other

<sup>1</sup>No IP protection

<sup>2</sup>IP20 max.

<sup>3</sup>IP30 max.

<sup>4</sup>Multipoint lock only

<sup>5</sup>Multipoint lock only, IP20 max.

<sup>6</sup>Multipoint lock only, IP30 max.

<sup>1</sup>No IP protection

<sup>2</sup>IP20 max.

<sup>3</sup>IP30 max.

<sup>4</sup>Multipoint lock only

<sup>5</sup>Multipoint lock only, IP20 max.

<sup>6</sup>Multipoint lock only, IP30 max.

<sup>7</sup>Lock code U or X only

<sup>8</sup>Lock code U or X only, IP20 max.

9. SIDE PANELS (BOTH SIDES)*	
Code	Note
O	No side panels
A	2 side panels, sheet steel, universal key
B	1 side panel, sheet steel, universal key
C	2 side panels, sheet steel, individual key
D	1 side panel, sheet steel, individual key
E	2 side panels, sheet steel with perforation, universal key
F	1 side panel, sheet steel with perforation, universal key
G	2 side panels, sheet steel with perforation, individual key
H	1 side panel, sheet steel with perforation, individual key
	Other

10. IP RATING <sup>1</sup>	
Code	Note
0	IP00
2	IP20
3	IP30
4	IP40
5	IP54 <sup>3</sup>
A	A/C ready <sup>2</sup>

<sup>1</sup>According to EN 60 529

<sup>2</sup>Ready for A/C unit installation; recommended when cooling planned or required; IP54 when A/C unit installed according to instructions

<sup>3</sup>Multipoint lock only

11. PLATES <sup>1</sup>			
Code	Top Plate	Bottom plate	Note
A	P	X	Top and bottom single piece plates required for IP54
C	no top	X	Open top – for A/C-ready option (table 10)
H	I	XXX/XXX <sup>2</sup>	Standard – one piece top plate, segmented bottom plate
I	I	no bottom <sup>3</sup>	Open bottom – ready for installation on raised floor or plinth
X	no top <sup>3</sup>	no bottom <sup>3</sup>	Open top and bottom, for individual plates go to page 21

<sup>1</sup>For more information on plates, see page 21

<sup>2</sup>800×800: CFC, 800×1 000: CHC, 800×1 200: CFFC

<sup>3</sup>Open top or bottom results in no IP protection, unless otherwise stated

12. LOAD RATING		
Code	Load rate (kg)	Note
3	400	27U only
5	800	Balanced load

13. COLOR	
Code	Note
B	RAL 7035 (light gray)
H	RAL 9005 (black)

\*Open side / sides result in no IP protection; side panels with perforation result in max. IP20 protection rating.

**Configure IT rack on-line** [www.conteg.com/configurators](http://www.conteg.com/configurators)

# PREMIUM HOUSING RSB



RSB-48-60/100-3

➤ The **PREMIUM Housing RSB** rack series is designed for server housing and co-location centers. All types of active or passive 19" equipment can be housed inside.



## MAIN ADVANTAGES

- Flexible server-housing rack for collocation and housing data centers
- 2, 3 and 4 individual compartments
- Unmatched 86% door perforation ratio decreases server fan power consumption
- Installable as standalone or in rows with other racks
- Individual cable guides for cable management
- Separation frame for each compartment

COLOR SAMPLER:  RAL 9005

 RAL 7035

## DESCRIPTION:

### Sizes

- Height: 42, 45, 48U (total useful height = 42/45/48 – number of compartments)
- Width: 600, 800 mm
- Depth: 1000 and 1200 mm

### Construction

- 1.5 & 2.0 mm sheet steel
- 2–4 compartments; other combinations upon request

### Load rating

- 1500 kg maximum load rating per frame
- Load rating 500 kg per 19" compartments; 100 kg per shelf

### IP rating

- IP20

### Colors

- Standard RAL 7035 and 9005

### Front and rear doors

- Vented door – perforation rate 86%
- Swivel handle lock – DIN profile, universal key 333, single point
- Door opening angle 180°
- Easy re-hanging to open on right or left

### Side panels

- Removable with locks

### Cable entries

- Top and bottom
- All cable entries covered with removable blank panels

### 19" Vertical extrusions

- 2 pairs of sliding 19" vertical L-type (600 mm) or C-type (800 mm) extrusions for each compartment
- P-type extrusions optional for RSB width 800 mm (2 and 3 compartments)

### Other

- Installable in blocks with DP-DR-UNI (ordered separately)
- GND/earthing kit included
- Individual cabling for each compartment (ordered separately)
- Air separation frame for all compartments (ordered separately)

## RSB RACKS

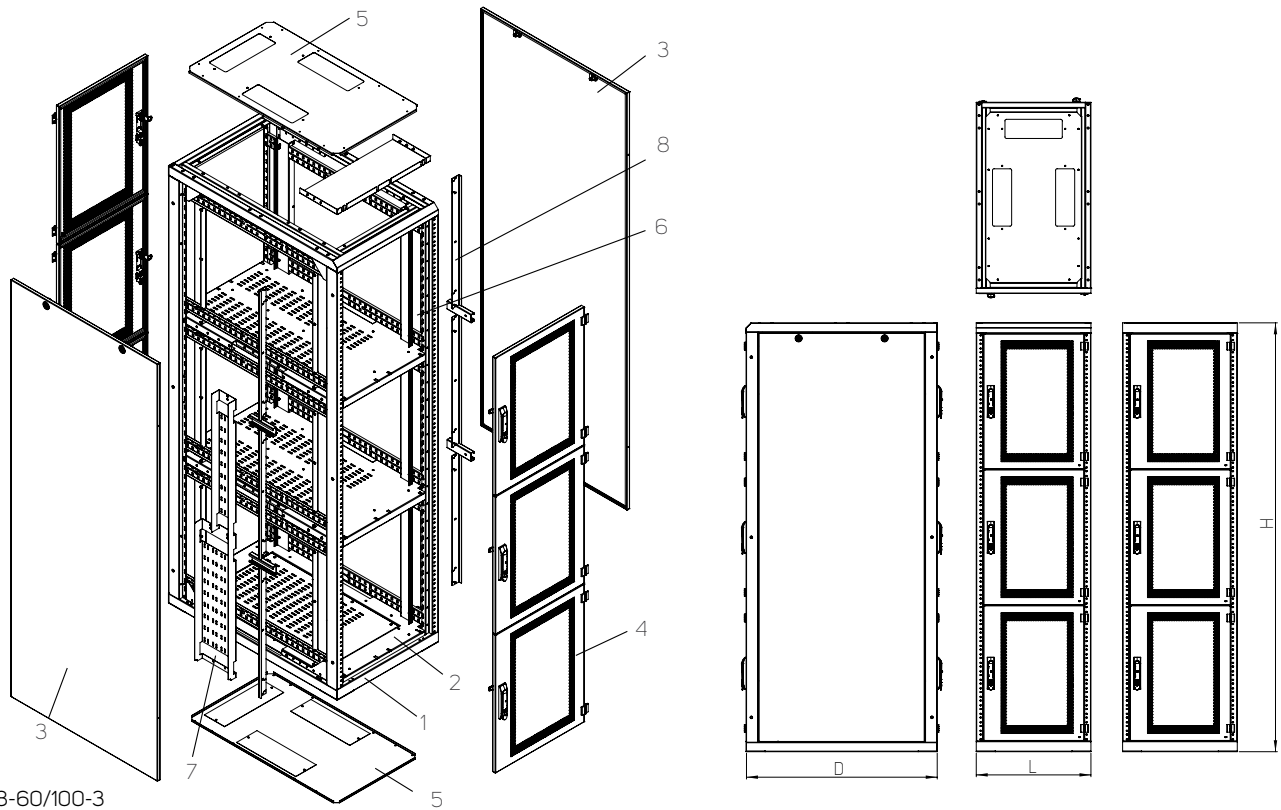

RSB-48-60/100-3

STANDARD CONFIGURATION (short Code only)*		OPTIONS	
1	Server housing rack frame	7	Set of individual cable guiding
2	3 pieces of high-load shelf	8	Separation frame for each compartment
3	2 removable side panels with locks		
4	6 pieces of vented doors with swivel handle lock		
5	Removable Z-design top and bottom plate with cable entry openings		
6	2 pairs of 19" vertical L-type extrusions for each compartment		
-	GND/earthing kit		
-	28 mounting kits		

\* Valid for RSB racks with 3 compartments

### RSB RACKS – TECHNICAL DATA AND DIMENSIONS

Code	H (in U)	Load rating (kg)	Dimensions (mm)				Dimensions incl. packing (mm)			Gross weight (kg) (compartments – 2 / 3 / 4)
			H*	W	D	Useful depth	H	W	D	
RSB-42-60/100	42	1500	1978	600	1000	931	2160	640	1040	137 / 158 / 181
RSB-45-60/100	45	1500	2111	600	1000	931	2290	640	1040	144 / 165 / 190
RSB-48-60/100	48	1500	2245	600	1000	931	2430	640	1040	151 / 173 / 198
RSB-42-60/120	42	1500	1978	600	1200	1131	2160	640	1240	165 / 188 / 219
RSB-45-60/120	45	1500	2111	600	1200	1131	2290	640	1240	174 / 196 / 230
RSB-48-60/120	48	1500	2245	600	1200	1131	2430	640	1240	184 / 205 / 240
RSB-42-80/100	42	1500	1978	800	1000	931	2160	840	1040	169 / 194 / 224
RSB-45-80/100	45	1500	2111	800	1000	931	2290	840	1040	175 / 202 / 231
RSB-48-80/100	48	1500	2245	800	1000	931	2430	840	1040	179 / 206 / 233
RSB-42-80/120	42	1500	1978	800	1200	1131	2160	840	1240	205 / 234 / 261
RSB-45-80/120	45	1500	2111	800	1200	1131	2290	840	1240	211 / 237 / 276
RSB-48-80/120	48	1500	2245	800	1200	1131	2430	840	1240	220 / 248 / 282

\* Height in mm without feet; for feet add 16–45 mm

**ORDERING AND SHIPPING INFORMATION:** Configure the rack that meets your requirements. The ordering matrix below will help you create a Code. As soon as you have the Code, please contact your Conteg products distributor. Please note that all RSB RACKS ARE DELIVERED FULLY ASSEMBLED and palletized!

## FOLLOW THE STEPS TO SET UP THE DESIRED RSB RACK CODE!

**R S B - 1. - 2. / 3. - 4. - 5.**

An example of a correct Code:

**R S B - 48 - 60 / 100 - 3 - B**

1. HEIGHT*		
Code	Height (in U)	External height (mm)
42	42	1978
45	45	2111
48	48	2245

\* Height in mm without feet

2. WIDTH	
Code	Width (mm)
60	600
80	800

3. DEPTH	
Code	Depth (mm)
100	1000
120	1200

4. NUMBER OF COMPARTMENTS	
Code	Options
2	2 compartments
3	3 compartments
4	4 compartments

5. COLOR	
Code	Note
B	RAL 7035 (light gray)
H	RAL 9005 (black)

ACCESSORIES	
Code	Description
RSB-CM-xx <sup>1</sup> -y <sup>2</sup>	Set for individual cable guiding of RSB racks, top or bottom cable entry <sup>3</sup>
DP-RSB-CW-y <sup>2</sup> -xx <sup>1</sup>	Set of air separation frames for RSB racks

<sup>1</sup>Substitute xx with height of RSB rack

<sup>2</sup>Substitute y with number of compartments

<sup>3</sup>Only RSB 45-2, 42-4 and 45-4 need to define top or bottom cable guiding; add as suffix to the end of code: -T for Top entry, -B for Bottom entry

## Recommended accessories



### Managed PDU

More information [on page 108](#)



### RAMOS Ultra

More information [on page 97](#)

# PREMIUM RACK SERIES PLATES

➤ **Conteg's PREMIUM** rack series gives you unlimited flexibility when planning the final configuration of your rack. Our product portfolio contains a unique interface between out-of-rack and in-rack cabling systems (such as OptiWay, Top Ducts and High Density Wire Management). Simply choose the plate design (quantity and type of cable entry openings) that perfectly suits your needs. All plates are applicable for RSF and RDF rack series.

## MAIN ADVANTAGES

- PREMIUM rack series with interchangeable top and bottom plates
- 4 different single-piece top plates
- 10 types of segmented bottom plates
- Applicable for RSF and RDF rack series (and for RSB racks, with some limitations)
- Compatible with out-of-rack and in-rack cabling systems
- Cabling systems (such as OptiWay, Top Ducts and High Density Wire Managers)

## BOTTOM PLATES

Segmented bottom plates consist of 3 or 4 per set, delivered separately in a carton box.

Any plate may be left out (incomplete bottom plate sets applicable – results in no IP protection). Write 0 if the position should be left empty.

Code	RDF/RSF width (mm)	Package
CO-BU-60-X-Y	600	1 pc
CO-BU-80-X-Y	800	1 pc

Single plates can be delivered in carton boxes. Choose suitable design and write the code (A–Z) instead of X. Write B for gray (RAL 7035) or H for black (RAL 9005) instead of Y.

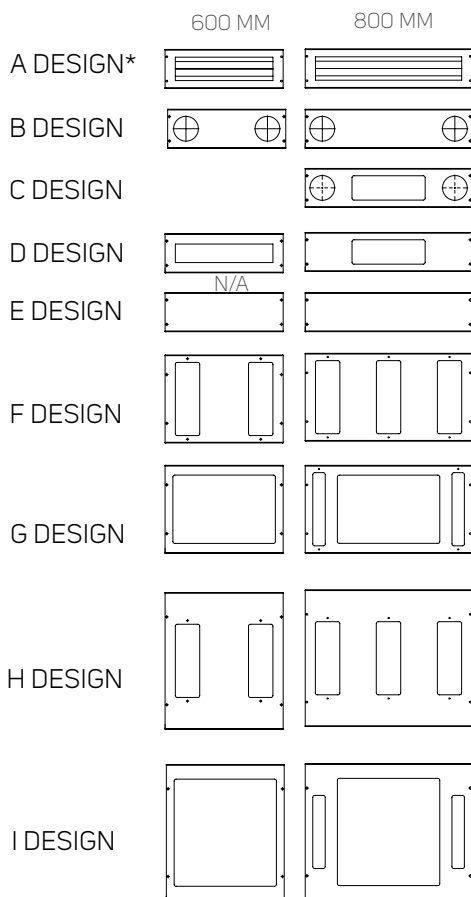

\* Divided, with double brush

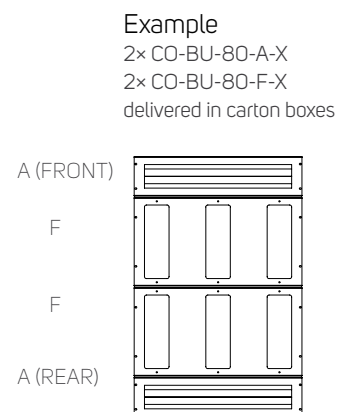
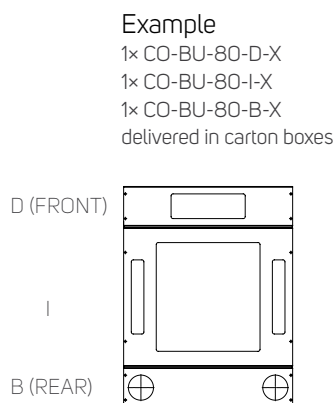
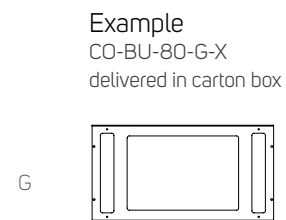
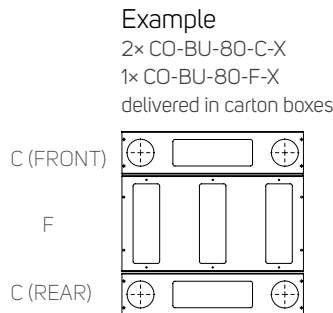

A, B, C, D, E design: lateral plates

Complete bottom plate always contains two plates of A, B, C, D or E design. Combination of two different plates allowed.

F, G design: central plates for 800 and 1200 mm deep racks

Complete bottom plate always contains one (800 mm deep racks) or two (1200 mm deep racks) plates of F or G design. Combination of two different plates is allowed.

H, I design: central plates for 1000 mm deep racks

Complete bottom cover always contains one plate of H or I design.

Bottom plate design	For rack width (mm)	Type of openings						
		300×100 mm	300×50 mm	4" (Ø 100 mm)	420×280 mm	420×440 mm	76×400 mm	76×600 mm
A	600	-	-	-	-	-	1x	-
	800	-	-	-	-	-	-	1x
B	600	-	-	2x	-	-	-	-
	800	-	-	2x	-	-	-	-
C	800	1x	-	2x	-	-	-	-
D	600	1x	-	-	-	-	-	-
	800	1x	-	-	-	-	-	-
E	600	-	-	-	-	-	-	-
	800	-	-	-	-	-	-	-
F	600	2x	-	-	-	-	-	-
	800	3x	-	-	-	-	-	-
G	600	-	-	-	1x	-	-	-
	800	-	2x	-	1x	-	-	-
H	600	2x	-	-	-	-	-	-
	800	3x	-	-	-	-	-	-
I	600	-	-	-	-	1x	-	-
	800	-	2x	-	-	1x	-	-

- Not available

## TOP PLATES

Single-pieces, with four different design options; delivered separately in a carton box, with blanking panels/plastic caps.

Code	RDF/RSF footprint (mm)	Package
CO-TU-60/80-X-Y	600×800	1 pc
CO-TU-60/100-X-Y	600×1000	1 pc
CO-TU-60/120-X-Y	600×1200	1 pc
CO-TU-80/80-X-Y	800×800	1 pc
CO-TU-80/100-X-Y	800×1000	1 pc
CO-TU-80/120-X-Y	800×1200	1 pc

Choose suitable design and write the code: B, I, F or Z (instead of X). Write B for gray (RAL 7035) or H for black (RAL 9005) instead of Y.

### B DESIGN

### F DESIGN

### I DESIGN

### Z DESIGN

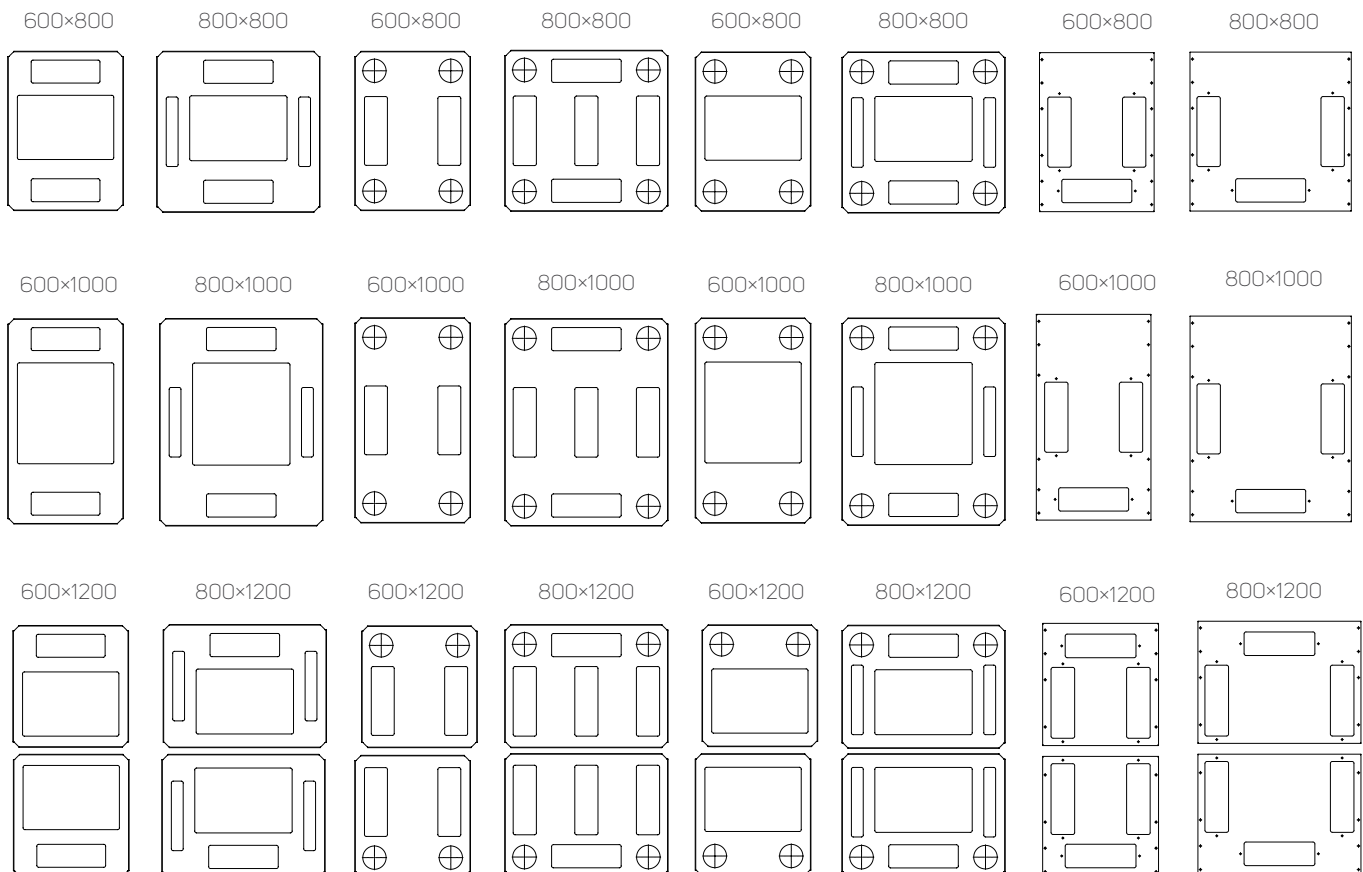

P and X designs are compatible upon request with IP54 (similar to Z design)

Note: All dimensions in mm



Top plate design	For rack dimensions (width × depth)	Opening type				
		300×100 mm	300×50 mm	4" (Ø 100 mm)	420×280 mm	420×440 mm
B	600×800	2×	–	–	1×	–
	600×1000	2×	–	–	–	1×
	600×1200	2×	–	–	2×	–
	800×800	2×	2×	–	1×	–
	800×1000	2×	2×	–	1×	1×
	800×1200	2×	4×	–	2×	–
F	600×800	2×	–	4×	–	–
	600×1000	2×	–	4×	–	–
	600×1200	4×	–	4×	–	–
	800×800	5×	–	4×	–	–
	800×1000	5×	–	4×	–	–
	800×1200	8×	–	4×	–	–
I	600×800	–	–	4×	1×	–
	600×1000	–	–	4×	–	1×
	600×1200	–	–	4×	2×	–
	800×800	2×	2×	4×	1×	–
	800×1000	2×	2×	4×	–	1×
	800×1200	2×	4×	4×	2×	–
Z	600×800	3×	–	–	–	–
	600×1000	3×	–	–	–	–
	600×1200	6×	–	–	–	–
	800×800	3×	–	–	–	–
	800×1000	3×	–	–	–	–
	800×1200	6×	–	–	–	–

– Not available

## Recommended accessories



### Cable protection DP-KP-KAR4

More information [on page 123](#)



### Cable protection DP-KP-RB4

More information [on page 123](#)



### Cable protection DP-KP-KAR

More information [on page 123](#)



### Cable protection DP-KP-KAR4-D

More information [on page 123](#)

# OPTIMAL PC ROP



ROP-36-65/60

➤ The **OPTIMAL PC ROP** is designed to both securely house and safely position a personal computer without user limitation, with the possibility of installing standard 19" equipment.



## MAIN ADVANTAGES

- Special solution to securely house PCs
- Three compartments for specific use

COLOR SAMPLER:  RAL 7035

Code	H (in U)	Dimensions (mm)				Dimensions including packing (mm)			Gross weight (kg)
		H*	W	D	Useful depth	H	W	D	
ROP-36-65/60	36	1721	650	600	590	1850	690	660	105

\* Height in mm without feet; for feet add 16–45 mm

## DESCRIPTION:

- |  |  |   |
|--|--|---|
| <p><b>Sizes</b></p> <ul style="list-style-type: none"> <li>• Height: 36U</li> <li>• Width: 650 mm</li> <li>• Depth: 600 mm</li> </ul> <p><b>Construction</b></p> <ul style="list-style-type: none"> <li>• Welded-frame design</li> <li>• 1.5 &amp; 2.0 mm sheet steel</li> </ul> <p><b>IP rating</b></p> <ul style="list-style-type: none"> <li>• Standard IP30</li> </ul> <p><b>Load rating</b></p> <ul style="list-style-type: none"> <li>• Frame – 400 kg</li> <li>• Bottom section – 300 kg</li> <li>• Top section – 100 kg</li> </ul> | <ul style="list-style-type: none"> <li>• Pull-out shelf – 10 kg</li> </ul> <p><b>Colors</b></p> <ul style="list-style-type: none"> <li>• Standard RAL 7035</li> <li>• Other colors optional</li> </ul> <p><b>Front door</b></p> <ul style="list-style-type: none"> <li>• Tinted security glass door with swivel handle lock – top part (12U)</li> <li>• Sheet steel door with swivel handle lock – bottom part (22U)</li> <li>• Door opening angle 180°</li> <li>• Lockable 2U pull-out shelf</li> </ul> <p><b>Rear panel</b></p> <ul style="list-style-type: none"> <li>• Removable, with lock</li> </ul> | <ul style="list-style-type: none"> <li>• Sheet steel or perforated sheet steel</li> </ul> <p><b>Side panels</b></p> <ul style="list-style-type: none"> <li>• Removable, with lock</li> <li>• Sheet steel or perforated sheet steel</li> </ul> <p><b>Cable entries</b></p> <ul style="list-style-type: none"> <li>• In top and bottom plate</li> <li>• Covered by removable blank panels</li> </ul> <p><b>Ventilation unit openings</b></p> <ul style="list-style-type: none"> <li>• In top and bottom plate</li> <li>• All ventilation unit openings covered by removable blank panels</li> </ul> <p><b>Feet</b></p> <ul style="list-style-type: none"> <li>• Adjustable feet standard</li> </ul> |
|--|--|---|

# OPTIMAL CABLE MANAGEMENT



ROF-CS-42-90/30 & ROF-CS-42-30/30

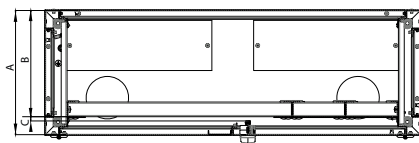

➤ The **OPTIMAL Cable Management** rack is designed to support either horizontal Cross Connect configuration or Consolidation Point topology based on ISO/IEC 11 801, TIA-942 and TIA-568 B standards. This solution is recommended for telecommunication rooms where active components and patch panels need to be separated.

## MAIN ADVANTAGES

- Specific system for High Density cabling or Consolidation point
- Flexible arrangement of inner components

## DIMENSIONS

Code	Specification	H (in U)	Dimensions (mm)	
			W	D
ROF-CS-42-90/30-CWYUA	Main Cable Management rack	42	900	300
ROF-CS-45-90/30-CWYUA	Main Cable Management rack	45	900	300
ROF-CS-42-90/40-CWYUA	Main Cable Management rack	42	900	400
ROF-CS-45-90/40-CWYUA	Main Cable Management rack	45	900	400
ROF-CS-42-30/30-SVYUA	Extension Cable Management rack	42	300	300
ROF-CS-45-30/30-SVYUA	Extension Cable Management rack	45	300	300
ROF-CS-42-30/40-SVYUA	Extension Cable Management rack	42	300	400
ROF-CS-45-30/40-SVYUA	Extension Cable Management rack	45	300	400

Code	Depth of rack	Total useful depth for installed equipment	19" Extrusions in front position	
			Rearward useful depth	Frontward useful depth
	A	B+C	B	C
ROF-CS-xx-90/30	300	264	254	10
ROF-CS-xx-90/40	400	364	354	10

COLOR SAMPLER:  RAL 9005

 RAL 7035

## DESCRIPTION:

### Sizes

- Height: 42, 45U
- Width of Main rack – 900 mm
- Width of Extended rack – 300 mm
- Depth: 300 or 400 mm

### Construction

- Welded-frame design
- 1.5 mm sheet steel
- Free-standing solution (attach to the wall or connect together)

### IP rating

- Standard IP30

### 19" Vertical extrusions

- Adjustable positioning of 19" extrusions – front to rear and left, central or right
- Pair of patch cord management panels
- When 19" extrusions are in front position of Main rack:

- Useful rearward depth is 254 mm for 300 mm and 354 mm for 400 mm depth of ROF-CS; when cable management accessories installed useful depth is different
- Useful frontward space limited by multipoint lock and ranges between 10 and 15 mm
- Extended rack can be attached to main Cable Management Rack at both sides

### Colors

- Standard RAL 7035 and 9005

### Front door

- Main rack – vertically divided sheet steel front doors, multipoint lock; rear and side panels with lock
- Extended rack – sheet steel front door, single point lock; rear and side panels with lock

### Rear and side panels

- Removable sheet steel door with lock

### Cable entries

- In top and bottom plate
- Covered by removable blank metal and plastic panels

### Feet

- Adjustable feet standard

### Cable management

- Management panels can be equipped with cable management accessories
  - Fibre storage spools – HDWM-FSS-50 or HDWM-FSS-100 (4× HDWM-FSS-50 included)
  - Plastic cable brackets – VO-xxx
  - Metal cable brackets – VO-Wx-xx/xx

### Package includes

- Main unit: rack, 19" frame, 2× management panels, 4× cable spools HDWM-FSS-50
- Extension unit: rack, 1× management panel, 2× cable spools HDWM-FSS-50

Comparison	ISEVEN RACK SERIES			
	R17	R17 SERVER	Flex RM7	Flex SERVER
	Welded-frame	Welded-frame	Demountable frame	Demountable frame
	Assembled	Assembled	Unassembled	Unassembled
	1.5 and 2 mm sheet steel	1.5 and 2 mm sheet steel	1.5 and 2 mm sheet steel	1.5 and 2 mm sheet steel
	See page 27	See page 32	See page 34	See page 38
<b>Appropriate use</b>				
Server rack	++	+++	+	+++
Data rack	+++	+++	+++	+++
Cable rack	+++	++	+++	++
Data centers	+	++	+	++
<b>Balanced load rating</b>				
Up to 300 kg	yes	-	yes	-
Up to 500 kg	yes	-	yes	-
Up to 1000 kg	-	yes	-	yes
<b>IP rating</b>				
IP20	yes	yes	yes	yes
IP30	yes	yes	yes	yes
<b>Baying</b>				
Side	yes	yes	yes	yes
<b>Targeted cooling</b>				
Door perforation 86%	yes	yes	yes	yes
Ventilation units	yes	yes	yes	yes
Side mount CoolTeg	yes	yes	yes	yes
<b>Cabling</b>				
Changeable internal configuration	yes	yes	yes	yes
Supports HDWM (Cat. 6A and higher)	yes	yes	yes	yes
Supports OptiWay	yes	yes	yes	yes
Supports TopDucts	yes	yes	yes	yes
<b>Size</b>				
15U	yes	-	yes	-
21U	yes	-	yes	-
27U	yes	-	yes	-
33U	yes	-	yes	-
42U	yes	yes	yes	yes
45U	yes	yes	yes	yes
48U	yes	-	yes	-
<b>Colors</b>				
Black RAL 9005	yes	yes	yes	yes
Light gray RAL 7035	yes	yes	yes	yes
<b>Locking system</b>				
Singlepoint	yes	yes	yes	yes
<b>Security options</b>				
Access control system	yes	yes	yes	yes
Airflow management	yes	yes	yes	yes
Monitoring indoor and outdoor environment	yes	yes	yes	yes

General comparisons of IT rack series; for technical details see appropriate catalog pages.

# iSEVEN RI7



RI7- 42-80/80

➤ The **iSEVEN RI7** rack has been designed to provide users with an unmatched ratio between price, utility value and quality. Ideal for installers and end-users who want to spend less time choosing between various options.

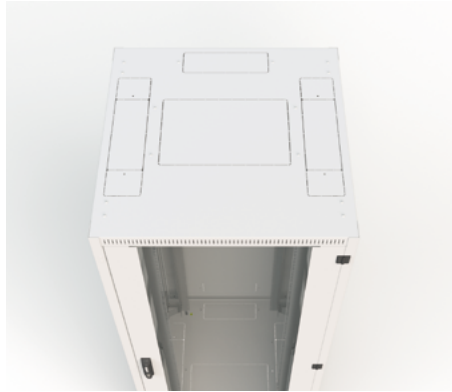

## MAIN ADVANTAGES

- Universal rack for standard daily IT use
- Available in 35 dimensions
- Pre-configured rack, with many other options

COLOR SAMPLER:  RAL 9005

 RAL 7035

## DESCRIPTION:

### Sizes

- Height: 15, 21, 27, 33, 42, 45, 48U
- Width: 600, 800 mm
- Depth: 600, 800, 1000 mm

### Construction

- Welded-frame design
- 1.5 & 2 mm sheet steel

### Load rating

- 15 – 33U: 300 kg
- 42 – 48U: 500 kg

### 19" Vertical extrusions

- 2 pairs of sliding 19" extrusions, adjustable from inside

### IP rating

- Standard IP30

### Colors

- Standard RAL 7035 and 9005

### Front door

- Security glass door with swivel handle lock – DIN profile, universal key 333
- Optional: sheet steel door, perforated door or vented door – perforation rate 86%
- Easy re-hanging to open on right or left
- Door opening angle 180°

### Rear panel

- Removable, with knock-out cable entry and lock
- Optional: sheet steel door, perforated door or vented door – perforation rate 86%

### Side panels

- Removable, with locks

### Knock-out openings – cable entry

- Universal size 300×100 mm – rear side of top and bottom plate and rear panel

- Universal openings can be covered by blank panels (ordered separately)
- Extended size 500×115 mm – both sides of top and bottom plate. Consists of 3 parts – 300×115 mm and 2× – 100×115 mm, each of which can be opened individually.
- Extended opening can be covered by blank panel or standard cable brush – middle opening. Opening can be protected by rubber edge piece (DP-KP-LEM-6) or brushes (DP-KP-KAR-6).

### Knock-out openings – ventilation unit installation

- Standard size 480×280 mm (1000 mm deep – 480×440 mm)
- Available in top and bottom plate
- Can be covered with blank panels (ordered separately)

### Adjustable Feet

## iSEVEN RI7 RACKS – TECHNICAL DATA AND DIMENSIONS

Code	H (in U)	Load rating (kg)	Dimensions (mm)				Dimensions including packing (mm)			Gross weight (kg)
			H*	W	D	Useful depth	H	W	D	
RI7-15-60/60	15	300	778	600	600	590	913	640	640	43
RI7-21-60/60	21	300	1045	600	600	590	1179	640	640	52
RI7-27-60/60	27	300	1311	600	600	590	1446	640	640	61
RI7-33-60/60	33	300	1578	600	600	590	1713	640	640	72
RI7-42-60/60	42	500	1978	600	600	590	2113	640	640	83
RI7-45-60/60	45	500	2111	600	600	590	2246	640	640	88
RI7-48-60/60	48	500	2245	600	600	590	2380	640	640	95
RI7-15-60/80	15	300	778	600	800	790	913	640	840	54
RI7-21-60/80	21	300	1045	600	800	790	1179	640	840	61
RI7-27-60/80	27	300	1311	600	800	790	1446	640	840	70
RI7-33-60/80	33	300	1578	600	800	790	1713	640	840	81
RI7-42-60/80	42	500	1978	600	800	790	2113	640	840	94
RI7-45-60/80	45	500	2111	600	800	790	2246	640	840	100
RI7-48-60/80	48	500	2245	600	800	790	2380	640	840	106
RI7-15-60/100	15	300	778	600	1000	990	913	640	1040	65
RI7-21-60/100	21	300	1045	600	1000	990	1179	640	1040	70
RI7-27-60/100	27	300	1311	600	1000	990	1446	640	1040	77
RI7-33-60/100	33	300	1578	600	1000	990	1713	640	1040	92
RI7-42-60/100	42	500	1978	600	1000	990	2113	640	1040	108
RI7-45-60/100	45	500	2111	600	1000	990	2246	640	1040	115
RI7-48-60/100	48	500	2245	600	1000	990	2380	640	1040	120
RI7-15-80/80	15	300	778	800	800	790	913	840	840	65
RI7-21-80/80	21	300	1045	800	800	790	1179	840	840	73
RI7-27-80/80	27	300	1311	800	800	790	1446	840	840	84
RI7-33-80/80	33	300	1578	800	800	790	1713	840	840	95
RI7-42-80/80	42	500	1978	800	800	790	2113	840	840	116
RI7-45-80/80	45	500	2111	800	800	790	2246	840	840	120
RI7-48-80/80	48	500	2245	800	800	790	2380	840	840	124
RI7-15-80/100	15	300	778	800	1000	990	913	840	1040	74
RI7-21-80/100	21	300	1045	800	1000	990	1179	840	1040	82
RI7-27-80/100	27	300	1311	800	1000	990	1446	840	1040	90
RI7-33-80/100	33	300	1578	800	1000	990	1713	840	1040	108
RI7-42-80/100	42	500	1978	800	1000	990	2113	840	1040	125
RI7-45-80/100	45	500	2111	800	1000	990	2246	840	1040	130
RI7-48-80/100	48	500	2245	800	1000	990	2380	840	1040	139

\* Height in mm without feet; for feet add 16-45 mm



# iSEVEN R17 RACKS

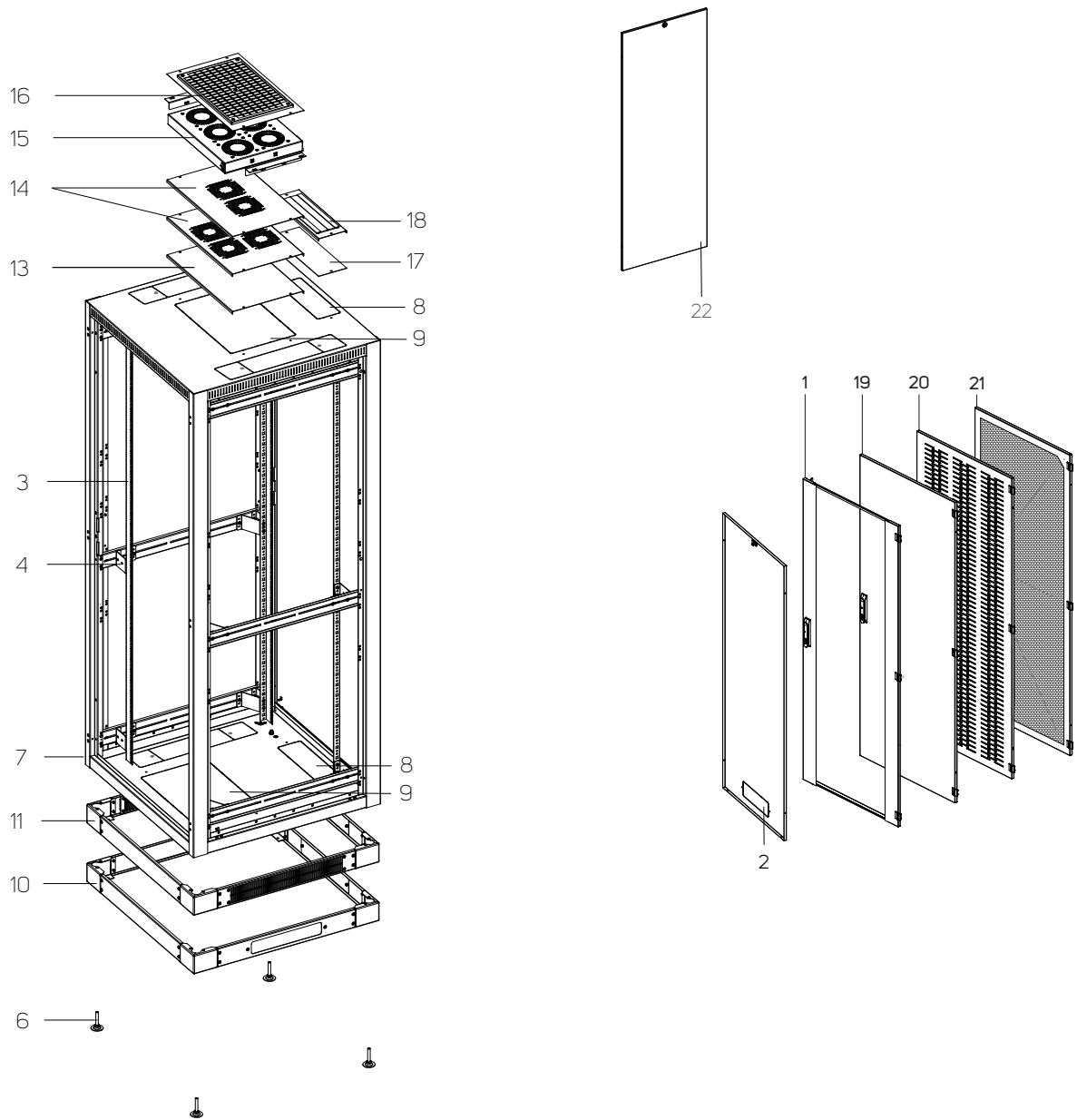

STANDARD CONFIGURATION (short Code only)		OPTIONS	
1	Glass door	10	Plinth
2	Rear panel with knock-out cable entry	11	Plinth with filter
3	4 pcs of 19" vertical extrusions	13	Blank panel
4	Holders for vertical extrusions	14	Blank panels for ventilation unit openings
6	Adjustable feet	15	Ventilation unit
7	Frame of rack	16	Connecting kit with filter for ventilation unit
8	Top and bottom knock-out openings for cable entry	17	Blank panel for cable entry openings
9	Top and bottom knock-out openings for ventilation unit	18	Dust-proof panel with brush for cable entry openings
22	Side panel	19	Sheet steel door
-	GND/earthing kit	20	Perforated sheet steel door
-	28 mounting kits	21	Vented door – perforation 86%

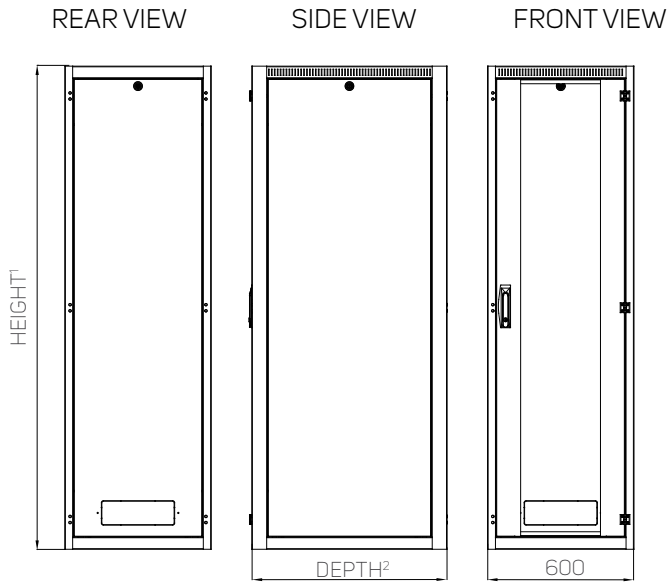

TOP VIEW

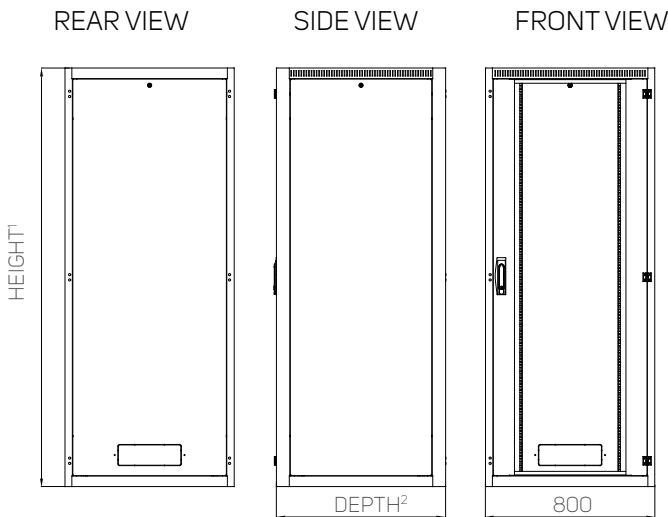
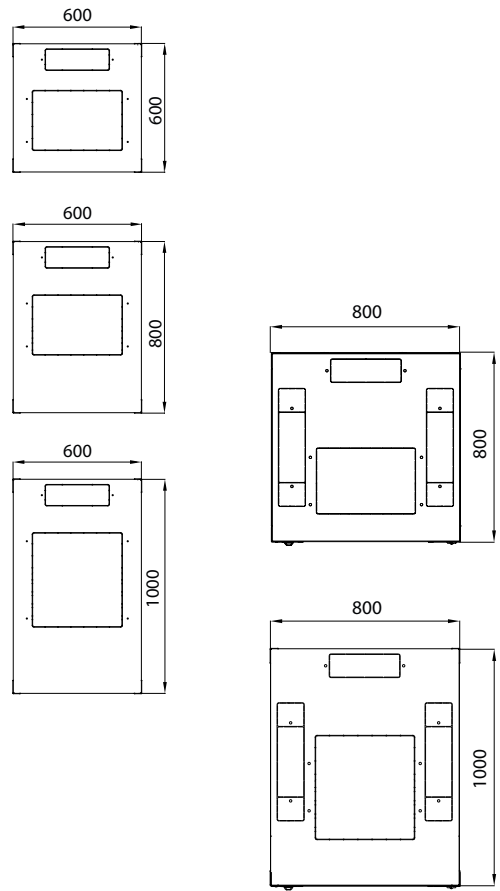

EXAMPLE – OPENED DOOR

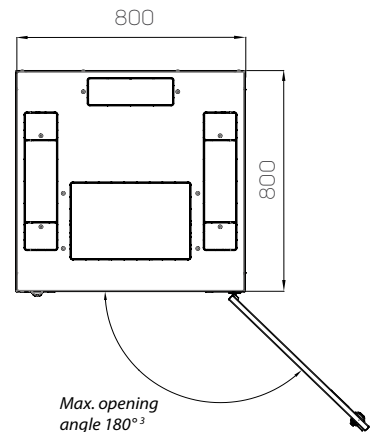

<sup>1</sup> Available heights:

- 15U/778 mm
- 21U/1044 mm
- 27U/1311 mm
- 33U/1578 mm
- 42U/1978 mm
- 45U/2111 mm
- 48U/2245 mm

<sup>2</sup> Available depths:

- for width 600 mm: 600, 800, 1000 mm
- for width 800 mm: 800, 1000 mm

<sup>3</sup> When rear doors applied (rear panel standard), max. angle 180 degrees

**Ventilation unit openings**

420×280 mm (depth 1000 mm – 420×440 mm)

**Cable entries**

300×100 mm 1× on top and bottom – rear  
 500×115 mm 2× on top and bottom – side for width 800 mm

Note: All dimensions in mm

**ORDERING AND SHIPPING INFORMATION:** Configure the rack that meets your requirements. The ordering matrix below will help you create a Code. As soon as you have the Code, please contact your Conteg products distributor. Please note that all RI7 RACKS ARE DELIVERED FULLY ASSEMBLED and palletized!

**FOLLOW THE STEPS TO SET UP THE DESIRED RI7 RACK CODE!**

**R I 7 - 1. - 2. / 3. 4. - 5. 6. 7. 8. 9. - 10. 11. 12. - 13.**

An example of a correct Code:

**R I 7 - 45 - 60 / 6 0 - G V S V A - 3 0 4 - H**

1. HEIGHT		
Code	Height (in U)	External height (mm)
15	15	778
21	21	1045
27	27	1311
33	33	1578
42	42	1978
45	45	2111
48	48	2245

2. WIDTH	
Code	Width (mm)
60	600
80	800

3. DEPTH		
Code	Depth (mm)	Useful depth (mm)
6	600	590
8	800	790
10	1000	990

4. EXTRUSIONS			
Code	Front pair	Rear pair	Note
0	L	L	L-type undivided extrusions

5. FRONT DOOR	
Code	Note
O	Without door <sup>1</sup>
G	Glass door
S	Sheet steel door
P	Perforated sheet steel door <sup>2</sup>
W	Vented door (perforation rate 86%) <sup>2</sup>
	Other

6. FRONT DOOR LOCK	
Code	Note
V	Swivel handle DIN profile, universal key, 333
	Other

7. REAR DOOR / PANEL	
Code	Note
O	Without panel/door <sup>1</sup>
G	Glass door
S	Sheet steel door
P	Perforated sheet steel door <sup>2</sup>
W	Vented door (perforation rate 86%) <sup>2</sup>
Y	Rear panel – single piece
	Other

8. REAR DOOR / PANEL LOCK	
Code	Options
V	Swivel handle DIN profile, universal key, 333
U	Lock for rear panel, universal key
	Other

<sup>1</sup>No IP protection  
<sup>2</sup>IP20 max.

<sup>1</sup>No IP protection  
<sup>2</sup>IP20 max.

9. SIDE PANELS (BOTH SIDES)*	
Code	Note
O	No side panels
A	2 side panels, sheet steel, universal key
	Other

10. IP RATING <sup>1</sup>	
Code	Note
0	IP00
2	IP20
3	IP30

11. PLATES	
Code	Options
O	Top & bottom plates – Integral

12. LOAD RATING		
Code	Load rate (kg)	Note
3	300	for rack heights 15–33U
4	500	for rack heights 42–48U

\* Open side/sides result in no IP protection

<sup>1</sup>According to EN 60 529

13. COLOR	
Code	Note
B	RAL 7035 (light gray)
H	RAL 9005 (black)



**Configure IT rack on-line** [www.conteg.com/configurators](http://www.conteg.com/configurators)

# iSEVEN SERVER



RI7- 42-80/100-S2

➤ The **iSEVEN SERVER** rack is ideal for anyone who needs to house servers properly. The iSEVEN SERVER combines our day-to-day rack with the highly valuable features of our RSF pure server rack.



## MAIN ADVANTAGES

- Server rack for standard IT hardware up to 1000 kg
- Unmatched 86% door perforation ratio decreases server fan power consumption
- Extrusions support Zero U (0U) PDU

COLOR SAMPLER:  RAL 9005

 RAL 7035

## DESCRIPTION:

### Sizes

- Height: 42U, 45U
- Width: 600, 800 mm
- Depth: 1000, 1200 mm

### Construction

- Welded-frame design
- 1.5 & 2 mm sheet steel

### Load rating

- 42–45U: 1000 kg

### 19" Vertical extrusions

- A-type extrusions, non-divided (600 or 800 mm wide) extrusions without horizontal holders (for 800 mm provide additional 24U of installation space); adjustable from inside, blank panels not included.

### IP rating

- Standard IP20

### Colors

- Standard RAL 7035 and 9005

### Front door

- Vented door – perforation rate 86%
- Swivel handle lock, DIN profile, universal key 333, singlepoint

### Rear door

- Vented door – perforation rate 86%
- Swivel handle lock, DIN profile, universal key 333, singlepoint

### Side panels

- Removable, with locks

### Knock-out openings – cable entry

- Universal size 300×100 mm – rear side of top and bottom plate and rear panel
- Universal openings can be covered with blank panels (ordered separately)

- Extended size 500×115 mm – only for 800 mm width – both sides of top and bottom plate. Consists of 3 parts – 300×115 mm and 2× – 100×115 mm, each of which can be opened individually.
- Extended opening can be covered by a blank panel or standard cable brush – middle opening. Opening can be protected by rubber edge piece (DP-KP-LEM-6) or brush (DP-KP-KAR-6).

### Knock-out openings – ventilation unit installation

- Standard size – 420×440 mm for 1000 mm depth – 420×280 mm (2×) for 1200 mm depth
- Available in top and bottom plate
- Can be covered with blank panels (ordered separately)

### Adjustable Feet

## ISEVEN SERVER RACKS

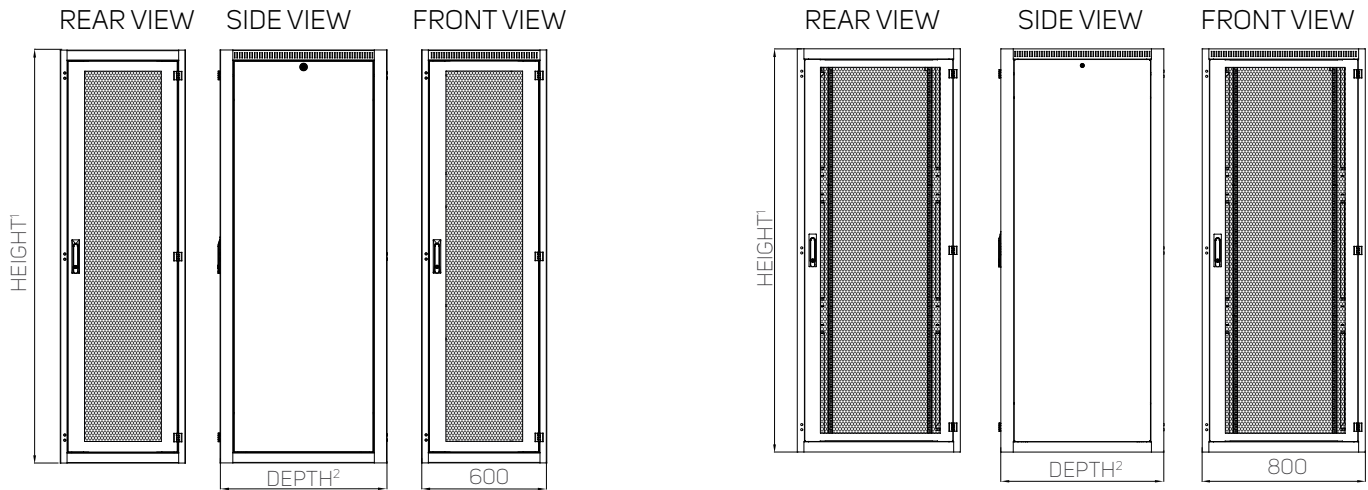

### TOP VIEW

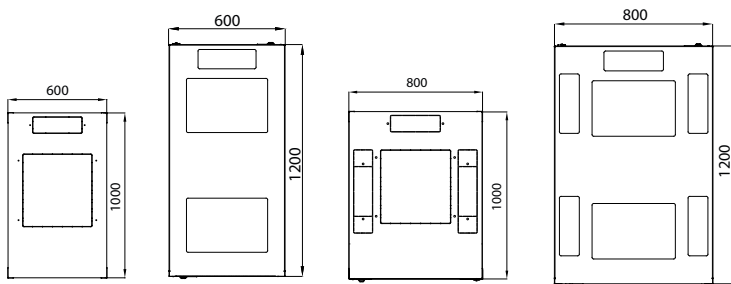

### EXAMPLE – OPENED DOOR

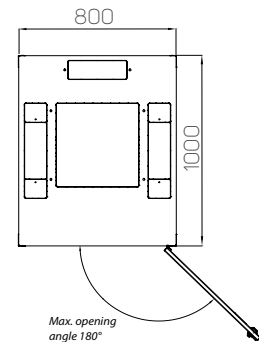

#### <sup>1</sup> Available heights:

- for width 600 mm: 42U/1978 mm, 45U/2111 mm
- for width 800 mm: 42U/1978 mm, 45U/2111 mm

#### <sup>2</sup> Available depths:

- for width 600 mm: 1000, 1200 mm
- for width 800 mm: 1000, 1200 mm

### Ventilation unit openings

- 1000 mm rack depth – 420×440 mm
- 1200 mm rack depth – 420×280 mm (2×)

### Cable entries

- 300×100 mm 1×on top and bottom – rear (for 600 mm width)
- 300×100 mm 5×on top and bottom – rear (for 600 mm width, 1200 mm deep rack)
- 500×115 mm 2×on top and bottom – side (for 800 mm width)

## ISEVEN SERVER – TECHNICAL DATA AND DIMENSIONS

Code	Height (in U)	Width (mm)	Depth (mm)	Color
RI7-42-60/100-S1-B	42	600	1000	RAL 7035
RI7-42-60/100-S1-H	42	600	1000	RAL 9005
RI7-42-60/120-S1-B	42	600	1200	RAL 7035
RI7-42-60/120-S1-H	42	600	1200	RAL 9005
RI7-45-60/100-S1-B	45	600	1000	RAL 7035
RI7-45-60/100-S1-H	45	600	1000	RAL 9005
RI7-45-60/120-S1-B	45	600	1200	RAL 7035
RI7-45-60/120-S1-H	45	600	1200	RAL 9005
RI7-42-80/100-S2-B	42	800	1000	RAL 7035
RI7-42-80/100-S2-H	42	800	1000	RAL 9005
RI7-42-80/120-S2-B	42	800	1200	RAL 7035
RI7-42-80/120-S2-H	42	800	1200	RAL 9005
RI7-45-80/100-S2-B	45	800	1000	RAL 7035
RI7-45-80/100-S2-H	45	800	1000	RAL 9005
RI7-45-80/120-S2-B	45	800	1200	RAL 7035
RI7-45-80/120-S2-H	45	800	1200	RAL 9005



# iSEVEN FLEX RM7



RM7- 42-80/80

> **Flex RM7** racks have been designed for users whose access path constraints do not allow for installation of the iSEVEN rack series (R17) with a welded design. iSEVEN Flex racks are delivered unassembled for easy transportation to the installation site, where they can be assembled quickly and easily.



## MAIN ADVANTAGES

- > Universal rack for standard daily use
- > Unassembled version for transport to inaccessible spaces

COLOR SAMPLER:  RAL 9005

 RAL 7035

## DESCRIPTION:

### Sizes

- Height: 21, 27, 42, 45U
- Width: 600 and 800 mm
- Depth: 800 and 1000 mm

### Construction

- Robust frame design, joined by 32 M6×12 screws
- Delivered unassembled; assembly at installation site
- Quick and easy assembly
- 1.5 & 2 mm sheet steel

### Load rating

- 21 & 27U: 300 kg
- 42 & 45U: 500 kg

### 19" Vertical extrusions

- 2 pairs of sliding 19" extrusions, adjustable from inside

### IP rating

- Standard IP30

### Colors

- Standard RAL 7035 and 9005

### Front door

- Security glass door with swivel handle lock – DIN profile, universal key 333
- Optional: sheet steel door, perforated door or vented door – perforation rate 86%
- Easy re-hanging to open on right or left
- Door opening angle 180°

### Rear panel

- Removable, with knock-out cable entry and lock
- Optional: sheet steel door, perforated door or vented door – perforation rate 86%

### Side panels

- Removable, with locks

### Knock-out openings – cable entry

- Universal size 300×100 mm – rear side of top and bottom plate and rear panel

- Universal openings can be covered with blank panels (ordered separately)
- Extended size 500×115 mm – both sides of top and bottom plate. Consists of three parts – 300×115 mm and 2× – 100×115 mm, each of which can be opened individually.
- Extended opening can be covered with blank panel or standard cable brush – middle opening. Opening can be protected by rubber edge piece (DP-KP-LEM-6) or brushes (DP-KP-KAR-6).

### Knock-out openings – ventilation unit installation

- Standard size 480×280 mm (1000 mm deep – 480×440 mm)
- Available in top and bottom plate
- Can be covered with blank panels (ordered separately)

### Adjustable Feet

## iSEVEN FLEX RM7 RACKS

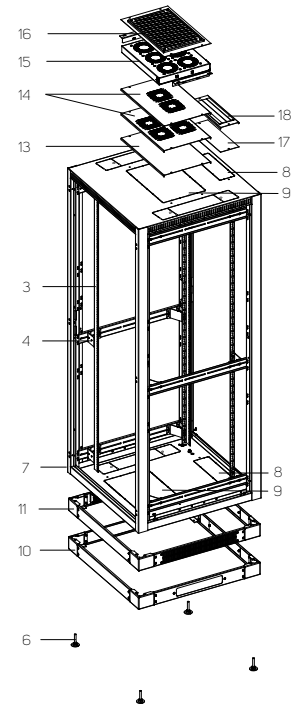
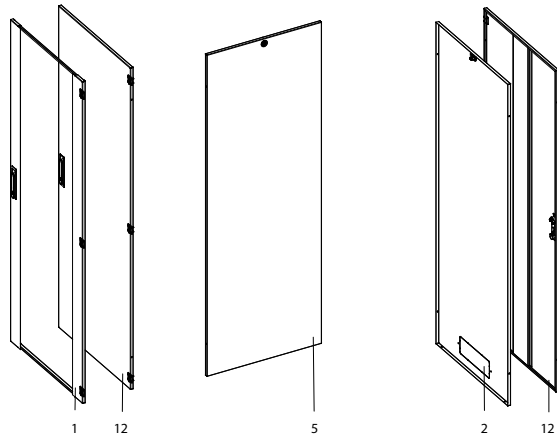

STANDARD CONFIGURATION		OPTIONS	
1	Front glass door with swivel handle lock	10	Plinth
2	Rear sheet steel panel with knock-out opening for cable entry and lock	11	Plinth with filter
3	4 pcs of 19" vertical extrusions	12	Sheet steel door
4	Holder for vertical extrusions	14	Blank panels for ventilation unit openings
5	1 pair of side sheet steel panels with lock	15	Ventilation unit
6	Adjustable feet	16	Connecting kit with filter for ventilation unit
7	Rack frame	17	Blank panel for cable entry openings
8	Top and bottom knock-out openings for cable entry	18	Dust-proof panel with brush for cable entry openings
9	Top and bottom knock-out openings for ventilation unit		
-	GND/earthing kit		
-	28 mounting kits		

## iSEVEN FLEX RM7 RACK – TECHNICAL DATA AND DIMENSIONS

Code - Standard configuration <sup>1</sup>	H (in U)	Rack dimensions (mm)				Package dimensions (mm)				
		H *	W	D	Useful depth	Package 1 RM7-CO-xx/yy <sup>2</sup>	Package 2 RM7-TB-yy/zz <sup>2</sup>	Package 3 RM7-DO-xx/yy <sup>2</sup>	Package 4 RM7-SP-xx/zz <sup>2</sup>	Package 5 RM7-HVE-yy/zz <sup>2</sup>
RM7-21-60/60-X	21	1044	600	600	590	105×140×1165	630×620×135	550×70×955	520×990×85	-
RM7-27-60/60-X	27	1311	600	600	590	105×140×1430	630×620×135	550×70×1255	520×1255×85	-
RM7-42-60/60-X	42	1978	600	600	590	105×140×2100	630×620×135	550×70×1890	520×1920×85	185×75×100
RM7-45-60/60-X	45	2111	600	600	590	105×140×2230	630×620×135	550×70×2020	520×2055×85	185×75×100
RM7-21-60/80-X	21	1044	600	800	790	105×140×1165	630×820×135	550×70×955	720×990×85	-
RM7-27-60/80-X	27	1311	600	800	790	105×140×1430	630×820×135	550×70×1255	720×1255×85	-
RM7-42-60/80-X	42	1978	600	800	590	105×140×2100	630×820×135	550×70×1890	720×1920×85	185×75×100
RM7-45-60/80-X	45	2111	600	800	790	105×140×2230	630×820×135	550×70×2020	720×2055×85	185×75×100
RM7-27-60/100-X	27	1311	600	1000	990	105×140×1430	630×1020×135	550×70×1255	920×1255×85	-
RM7-42-60/100-X	42	1978	600	1000	990	105×140×2100	630×1020×135	550×70×1890	920×1920×85	185×75×100
RM7-45-60/100-X	45	2111	600	1000	990	105×140×2230	630×1020×135	550×70×2020	920×2055×85	185×75×100
RM7-27-80/80-X	27	1311	800	800	790	105×140×1430	1005×820×135	750×70×1255	720×1255×85	-
RM7-42-80/80-X	42	1978	800	800	790	105×140×2100	1005×820×135	750×70×1890	720×1920×85	185×75×100
RM7-45-80/80-X	45	2111	800	800	790	105×140×2230	1005×820×135	750×70×2020	720×2055×85	185×75×100
RM7-27-80/100-X	27	1311	800	1000	990	105×140×1430	1005×1020×135	750×70×1255	720×1255×85	-
RM7-42-80/100-X	42	1978	800	1000	990	105×140×2100	1005×1020×135	750×70×1890	920×1920×85	185×75×100
RM7-45-80/100-X	45	2111	800	1000	990	105×140×2230	1005×1020×135	750×70×2020	920×2055×85	185×75×100

\* Height in mm without feet; for feet add 16–45 mm

<sup>1</sup> Substitute X with desired color: B – 7035 (light gray), H – 9005 (black)

<sup>2</sup> xx – Rack height; yy – Rack width; zz – Rack depth

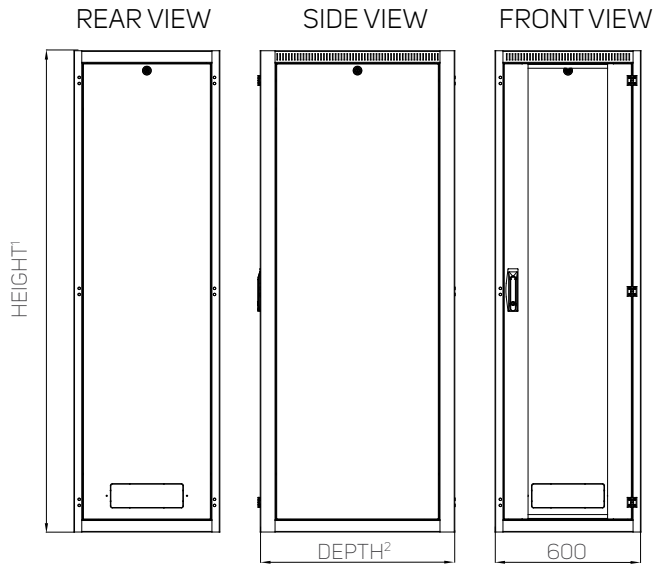

TOP VIEW

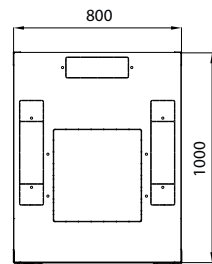
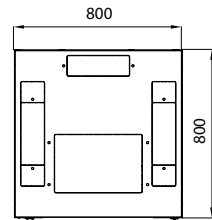
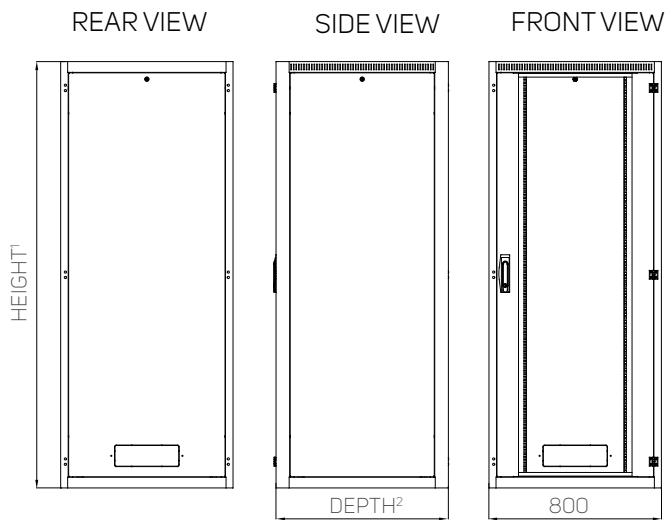
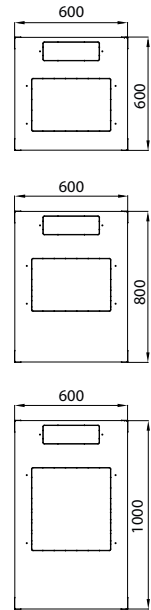

EXAMPLE – OPENED DOOR

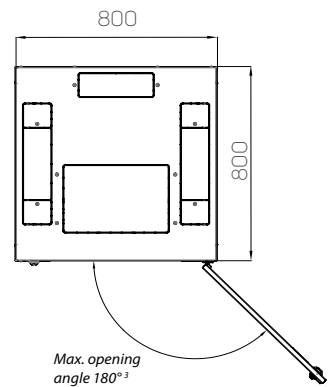

- <sup>1</sup> Available heights:  
 - for width 600 mm: 21U/1044 mm, 27U/1311 mm, 42U/1978 mm, 45U/2111 mm  
 - for width 800 mm: 27U/1311 mm, 42U/1978 mm, 45U/2111 mm
- <sup>2</sup> Available depths:  
 - for width 600 mm: 600, 800, 1000 mm  
 - for width 800 mm: 800, 1000 mm
- <sup>3</sup> When rear doors applied (rear panel standard) max. angle is 180°

**Ventilation unit openings**

420×280 mm (depth 1000 mm – 420×440 mm)

**Cable entries**

300×100 mm 1× on top and bottom – rear  
 500×115 mm 2× on top and bottom – side (for 800 mm width)

Note: All dimensions in mm

**ORDERING AND SHIPPING INFORMATION:** Configure the rack that meets your requirements. You can choose a standard or modified configuration for your iSEVEN Flex RM7 rack. The ordering matrix below will help you create a Code. As soon as you have the Code, please contact your Conteg products distributor. Please note that all iSEVEN Flex RM7 RACKS ARE DELIVERED UNASSEMBLED in 3–5 carton boxes!

#### iSEVEN FLEX RM7 RACK – STANDARD CONFIGURATION ORDERING TABLE

Code - Standard configuration <sup>1</sup>	Column code	Top and bottom plate codes	Door code	Side panel code	Holder code
RM7-21-60/60-X	RM7-CO-21/60-X	RM7-TB-60/60-X	RM7-DO-21/60-X	RM7-SP-21/60-X	-
RM7-27-60/60-X	RM7-CO-27/60-X	RM7-TB-60/60-X	RM7-DO-27/60-X	RM7-SP-27/60-X	-
RM7-42-60/60-X	RM7-CO-42/60-X	RM7-TB-60/60-X	RM7-DO-42/60-X	RM7-SP-42/60-X	RM7-HVE-60/60
RM7-45-60/60-X	RM7-CO-45/60-X	RM7-TB-60/60-X	RM7-DO-45/60-X	RM7-SP-45/60-X	RM7-HVE-60/60
RM7-21-60/80-X	RM7-CO-21/60-X	RM7-TB-60/80-X	RM7-DO-21/60-X	RM7-SP-21/80-X	-
RM7-27-60/80-X	RM7-CO-27/60-X	RM7-TB-60/80-X	RM7-DO-27/60-X	RM7-SP-27/80-X	-
RM7-42-60/80-X	RM7-CO-42/60-X	RM7-TB-60/80-X	RM7-DO-42/60-X	RM7-SP-42/80-X	RM7-HVE-60/80
RM7-45-60/80-X	RM7-CO-45/60-X	RM7-TB-60/80-X	RM7-DO-45/60-X	RM7-SP-45/80-X	RM7-HVE-60/80
RM7-27-60/100-X	RM7-CO-27/60-X	RM7-TB-60/100-X	RM7-DO-27/60-X	RM7-SP-27/100-X	-
RM7-42-60/100-X	RM7-CO-42/60-X	RM7-TB-60/100-X	RM7-DO-42/60-X	RM7-SP-42/100-X	RM7-HVE-60/100
RM7-45-60/100-X	RM7-CO-45/60-X	RM7-TB-60/100-X	RM7-DO-45/60-X	RM7-SP-45/100-X	RM7-HVE-60/100
RM7-27-80/80-X	RM7-CO-27/80-X	RM7-TB-80/80-X	RM7-DO-27/80-X	RM7-SP-27/80-X	-
RM7-42-80/80-X	RM7-CO-42/80-X	RM7-TB-80/80-X	RM7-DO-42/80-X	RM7-SP-42/80-X	RM7-HVE-80/80
RM7-45-80/80-X	RM7-CO-45/80-X	RM7-TB-80/80-X	RM7-DO-45/80-X	RM7-SP-45/80-X	RM7-HVE-80/80
RM7-27-80/100-X	RM7-CO-27/80-X	RM7-TB-80/100-X	RM7-DO-27/80-X	RM7-SP-27/100-X	-
RM7-42-80/100-X	RM7-CO-42/80-X	RM7-TB-80/100-X	RM7-DO-42/80-X	RM7-SP-42/100-X	RM7-HVE-80/100
RM7-45-80/100-X	RM7-CO-45/80-X	RM7-TB-80/100-X	RM7-DO-45/80-X	RM7-SP-45/100-X	RM7-HVE-80/100

<sup>1</sup>Substitute X with desired color: B – 7035 (light gray), H – 9005 (black)

#### iSEVEN FLEX RM7 – ITEM OVERVIEW OF INDIVIDUAL BOXES

Code <sup>1</sup>	Package includes
RM7-CO-xx/yy	4× column and 4× 19" vertical extrusion
RM7-TB-yy/zz	Top and bottom cover plate, 4× bracket for vertical extrusions
RM7-DO-xx/yy	Front door and rear panel (package contents may differ for customized versions)
RM7-SP-xx/zz	2× side panels
RM7-HVE-yy/zz <sup>2</sup>	2× bracket for vertical extrusions

<sup>1</sup>xx – Rack height; yy – Rack width; zz – Rack depth

<sup>2</sup>For 42U and 45U racks only, which require 6 brackets for vertical extrusions

Cover (modifications from standard configuration are written in bold script)	Itemized iSEVEN Flex rack Codes				
	Package 1	Package 2	Package 3	Package 4	Package 5
Front glass door, <b>rear sheet steel door</b> , 2 side panels	RM7-CO-xx/yy-X	RM7-TB-yy/zz-X	RM7-DO-xx/yy-GVSV-X	RM7-SP-xx/zz-X	RM7-HVE-yy/zz <sup>1</sup>
<b>Front sheet steel door</b> , rear sheet steel panel, 2 side panels	RM7-CO-xx/yy-X	RM7-TB-yy/zz-X	RM7-DO-xx/yy-SVYU-X	RM7-SP-xx/zz-X	RM7-HVE-yy/zz <sup>1</sup>
<b>Front sheet steel door</b> , <b>rear sheet steel door</b> , 2 side panels	RM7-CO-xx/yy-X	RM7-TB-yy/zz-X	RM7-DO-xx/yy-SVSV-X	RM7-SP-xx/zz-X	RM7-HVE-yy/zz <sup>1</sup>
Front glass door, rear sheet steel panel, <b>without side panels</b>	RM7-CO-xx/yy-X	RM7-TB-yy/zz-X	RM7-DO-xx/yy-X	-	RM7-HVE-yy/zz <sup>1</sup>
Front glass door, <b>rear sheet steel door</b> , <b>without side panels</b>	RM7-CO-xx/yy-X	RM7-TB-yy/zz-X	RM7-DO-xx/yy-GVSV-X	-	RM7-HVE-yy/zz <sup>1</sup>
<b>Front sheet steel door</b> , rear sheet steel panel, <b>without side panels</b>	RM7-CO-xx/yy-X	RM7-TB-yy/zz-X	RM7-DO-xx/yy-SVYU-X	-	RM7-HVE-yy/zz <sup>1</sup>
<b>Front sheet steel door</b> , <b>rear sheet steel door</b> , <b>without side panels</b>	RM7-CO-xx/yy-X	RM7-TB-yy/zz-X	RM7-DO-xx/yy-SVSV-X	-	RM7-HVE-yy/zz <sup>1</sup>

<sup>1</sup>Package 5 (RM7-HVE-yy/zz) is available for iSEVEN Flex racks 42 and 45U high only. Do not choose this package for racks 21U and 27U in height.

**Configure IT rack on-line** [www.conteg.com/configurators](http://www.conteg.com/configurators)

# iSEVEN FLEX SERVER



RM7-42-80/10A-S2

➤ The **iSEVEN Flex SERVER** rack is ideal for anyone who needs to house servers properly. The iSEVEN Flex SERVER combines our day-to-day rack with the highly valuable features of our RSF pure server rack. Comes with a mounted frame (delivered unassembled).



## MAIN ADVANTAGES

- Server rack for standard IT hardware up to 1000 kg
- Unmatched 86% door perforation ratio decreases server fan power consumption
- Unassembled version for transport to inaccessible spaces

COLOR SAMPLER:



RAL 9005



RAL 7035

## DESCRIPTION:

### Sizes

- Height: 42U
- Width: 600, 800 mm
- Depth: 1000 mm

### Construction

- Robust frame design, joined by 32 M6×12 screws
- Delivered unassembled; assembly at installation site
- Quick and easy assembly
- 1.5 & 2 mm sheet steel

### Load rating

- 42U: 1000 kg

### 19" Vertical extrusions

- A-type extrusions, non-divided (600 or 800 mm wide) extrusions without horizontal holders (for 800 mm provide additional 24U of installation space); adjustable from inside, blank panels not included.

### IP rating

- Standard IP20

### Colors

- Standard RAL 7035 and 9005

### Front door

- Vented door – perforation rate 86%
- Swivel handle lock, DIN profile, universal key 333, singlepoint

### Rear door

- Vented door – perforation rate 86%
- Swivel handle lock, DIN profile, universal key 333, singlepoint

### Side panels

- Removable, with locks

### Knock-out openings – cable entry

- Universal size 300×100 mm – rear side of top and bottom plate

- Universal openings can be covered with blank panels (ordered separately)
- Extended size 500×115 mm – for 800 mm width only – both sides of top and bottom plate. Consists of 3 parts – 300×115 mm and 2× – 100×115 mm, each of which can be opened individually.
- Extended opening can be covered with blank panel or standard cable brush - middle opening. Opening can be protected by rubber edge piece (DP-KP-LEM-6) or brush (DP-KP-KAR-6).

### Knock-out openings – ventilation unit installation

- Standard size 420×440 mm
- Available in top and bottom plate
- Can be covered with blank panels (ordered separately)

### Adjustable Feet

# ISEVEN FLEX SERVER RACKS

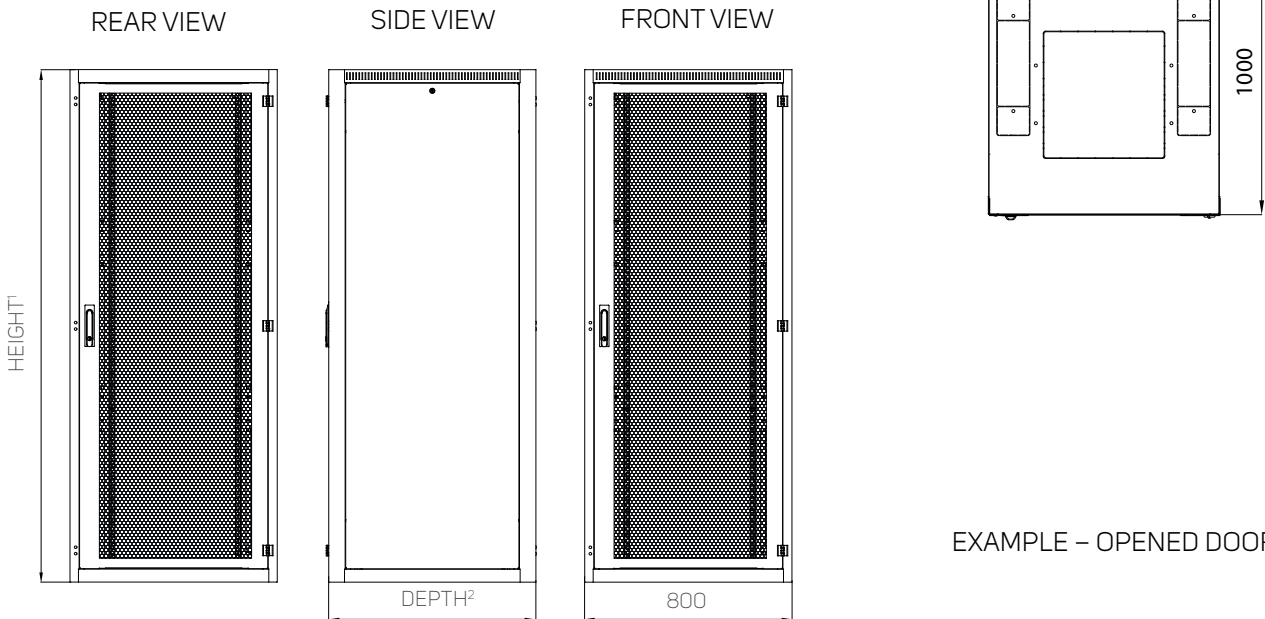
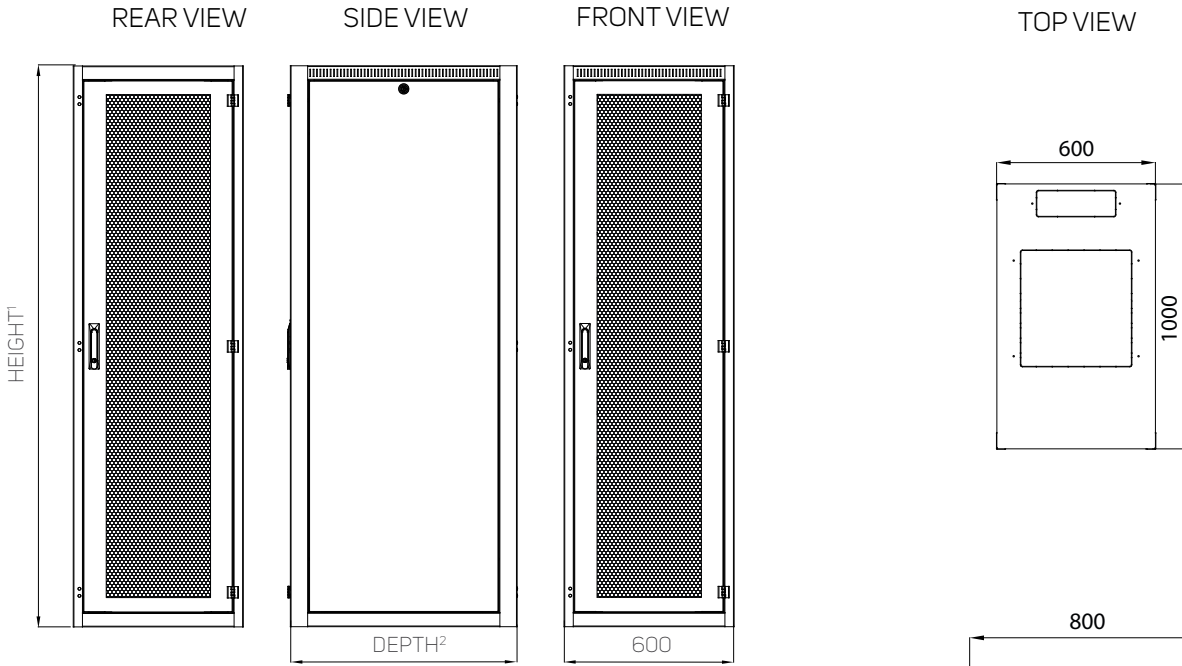

EXAMPLE – OPENED DOOR

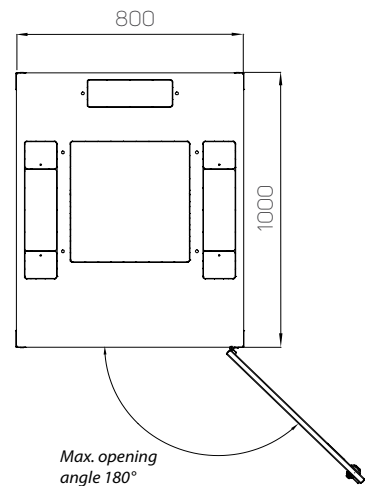

- <sup>1</sup> Available heights:  
 - for width 600 mm: 42U/1978 mm  
 - for width 800 mm: 42U/1978 mm

- <sup>2</sup> Available depths:  
 - for width 600 mm: 1000 mm  
 - for width 800 mm: 1000 mm

Ventilation unit openings  
 420x440 mm

Cable entries  
 300x100 mm 1x on top and bottom – rear  
 500x115 mm 2x on top and bottom – side (for 800 mm width)

Note: All dimensions in mm



**ORDERING AND SHIPPING INFORMATION:** Choose the iSEVEN Flex SERVER rack meeting your requirements from the table below. Each configuration comes with a separate list of components. After choosing the proper configuration and Codes, please contact your Conteg products distributor. Please note that all iSEVEN Flex SERVER RACKS ARE DELIVERED UNASSEMBLED (in 4 separate boxes)!

### iSEVEN FLEX SERVER STANDARD CONFIGURATION

- Top and bottom covers
- 4 columns
- 2 pairs of 19" A-profile sliding vertical extrusions
- 2 pairs of A-profile vertical extrusion holders
- Front vented door – perforation rate 86%, with swivel handle lock
- Rear vented door – perforation rate 86%, with swivel handle lock
- 1 pair of sheet steel side panels, with locks
- 4 adjustable feet
- GND / earthing kit
- 28 mounting kits

Code	Height (in U)	Height (mm)*	Width (mm)	Depth (mm)	Useful depth (mm)	Color
RM7-42-60/10A-S1-B	42	1978	600	1000	990	RAL 7035
RM7-42-60/10A-S1-H	42	1978	600	1000	990	RAL 9005
RM7-42-80/10A-S2-B	42	1978	800	1000	990	RAL 7035
RM7-42-80/10A-S2-H	42	1978	800	1000	990	RAL 9005

\* Height in mm without feet; for feet add 16–45 mm

Package information	For code RM7-42-60/10A-S1-B	For code RM7-42-60/10A-S1-H	Dimensions (mm) for RM7-42-60/10A-S1-B and RM7-42-60/10A-S1-H	For code RM7-42-80/10A-S2-B	For code RM7-42-60/10A-S1-H	Dimensions (mm) for RM7-42-80/10A-S2-B and RM7-42-60/10A-S1-H
Package 1	RM7-CO-42/6A-B	RM7-CO-42/6A-H	105×140×2100	RM7-CO-42/8A-B	RM7-CO-42/8A-H	105×140×2100
Package 2	RM7-TB-60/10A-S1-B	RM7-TB-60/10A-S1-H	630×1020×135	RM7-TB-80/10A-S2-B	RM7-TB-80/10A-S2-H	1005×1020×135
Package 3	RM7-DO-42/60-WVVV-B	RM7-DO-42/60-WVVV-H	550×70×1890	RM7-DO-42/80-WVVV-B	RM7-DO-42/80-WVVV-H	750×70×1890
Package 4	RM7-SP-42/100-B	RM7-SP-42/100-H	920×1920×85	RM7-SP-42/100-B	RM7-SP-42/100-H	920×1920×85

### Recommended accessories



#### 19" vented panel with brush

More information [on page 92](#)



#### Basic PDU

More information [on page 106](#)

# OPEN FRAMES RSG4



RSG4-42-19/92-LF

COLOR SAMPLER:  RAL 9005

➤ **RSG4** high-load, four post open frames ensure unbeatable accessibility. With a balanced load rating of up to 1500 kg, they are ideal for installation of heavy servers, disk arrays, etc.

## MAIN ADVANTAGES

- 4-post frame for heavy IT hardware (up to 1500 kg)
- Unlimited access for component installation
- Full on-site configurability and depth adjustment
- High Density Wire Management compatible

Code *	H (in U)	Dimensions (mm)		
		H	W	Depth settings
RSG4-42-19/50-LF	42	2055	550	500–680
RSG4-42-19/74-LF	42	2055	550	710–890
RSG4-42-19/92-LF	42	2055	550	920–1100
RSG4-45-19/50-LF	45	2188	550	500–680
RSG4-45-19/74-LF	45	2188	550	710–890
RSG4-45-19/92-LF	45	2188	550	920–1100
RSG4-47-19/50-LF	47	2277	550	500–680
RSG4-47-19/74-LF	47	2277	550	710–890
RSG4-47-19/92-LF	47	2277	550	920–1100

\* For inward-oriented base, replace L with X in product code

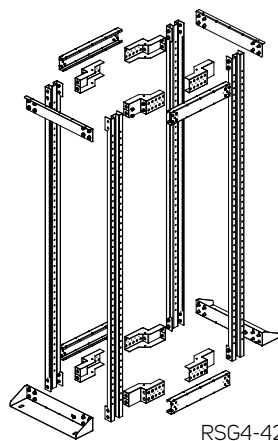

RSG4-42

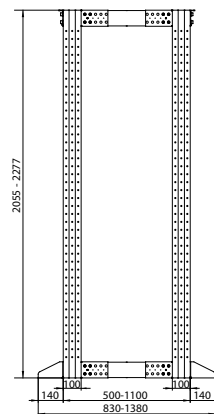

TOP VIEW

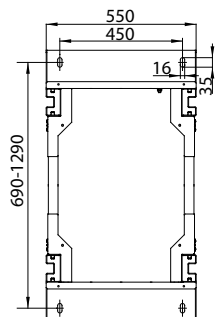

## DESCRIPTION:

### Sizes

- Height: 42, 45, 47U
- Width: 550 mm
- Depth: 500–680 mm, 710–890 mm, 920–1100 mm (step 30 mm)

### Load rating

- 1500 kg (balanced load)

### IP rating

- IP00 (no protection)

### Construction

- 2.0 mm sheet steel

### Color

- Standard RAL 9005

### Base

- Composed of sheet steel

- L – outward-oriented (X – inward-oriented optionally)
- Complete with holes for anchoring screws

### Standard equipment

- 2 pairs of 19" vertical extrusions (with U marking)
- Top angles
- 2× outward-oriented L-sheet steel base

Note: All dimensions in mm

# OPEN FRAMES RSG2

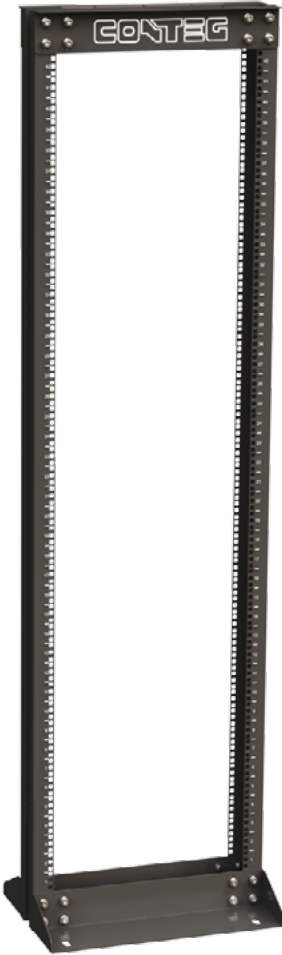

RSG2- 42-19-L5

COLOR SAMPLER:  RAL 9005

➤ **RSG2** high-load, two post open frames are designed to be used with High Density Wire Management.

## MAIN ADVANTAGES

- 2-post frame with 500 or 1000 kg load rating
- Universal frame for cable management (fully compatible with High Density Wire Management)
- Unlimited access to for component installation

Code	H (in U)	H (mm)	Load rating (kg)
RSG2-27-19-L5	27	1388	500
RSG2-42-19-L5	42	2055	500
RSG2-45-19-L5	45	2188	500
RSG2-47-19-L5	47	2277	500
RSG2-42-19-LA	42	2055	1000
RSG2-45-19-LA	45	2188	1000
RSG2-47-19-LA	47	2277	1000

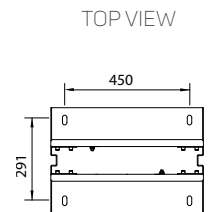
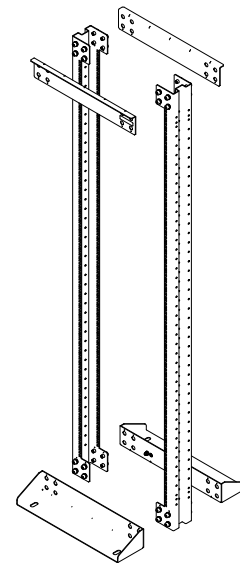
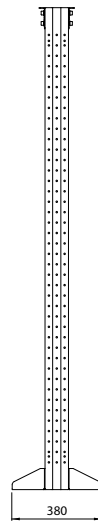
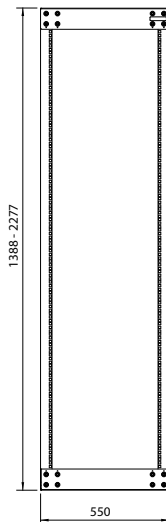

## DESCRIPTION:

- |   |   |   |
|---|---|---|
| <p><b>Sizes</b></p> <ul style="list-style-type: none"> <li>• Height: 27, 42, 45, 47U</li> <li>• Width: 550 mm</li> <li>• Depth: 100 mm</li> </ul> <p><b>Construction</b></p> <ul style="list-style-type: none"> <li>• 2.0 mm sheet steel</li> </ul> <p><b>Load rating</b></p> <ul style="list-style-type: none"> <li>• 500 kg (balanced load; all heights)</li> </ul> | <ul style="list-style-type: none"> <li>• 1000 kg (balanced load; 42U, 45U and 47U only)</li> </ul> <p><b>IP rating</b></p> <ul style="list-style-type: none"> <li>• IP00 (no protection)</li> </ul> <p><b>Color</b></p> <ul style="list-style-type: none"> <li>• Standard RAL 9005</li> </ul> | <p><b>Base</b></p> <ul style="list-style-type: none"> <li>• Composed of sheet steel</li> <li>• Complete with holes for anchoring screws</li> </ul> <p><b>Standard equipment</b></p> <ul style="list-style-type: none"> <li>• 1 pair of 19" vertical extrusions with U marking</li> <li>• Top angles</li> <li>• 2× base</li> </ul> |
|---|---|---|

Note: All dimensions in mm

# OPEN FRAMES RS



RS-P + RS-42

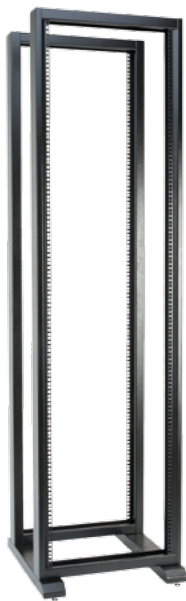

RS-P + 2x RS-42

➤ The RS frame series is used in closed rooms with controlled access, within a suitable operating environment for installed components, or wherever racks cannot be used.

## MAIN ADVANTAGES

- Light frame
- Single or double version

Configuration order quantities						
H (in U)	Code	19" two post frames	19" four post frames	Dimensions (mm)		
				W	D	H
27U	RS-27	1	2	559	600	1339
	RS-P	1	1			
36U	RS-36	1	2	559	600	1739
	RS-P	1	1			
42U	RS-42	1	2	559	600	2005
	RS-P	1	1			
45U	RS-45	1	2	559	600	2139
	RS-P	1	1			

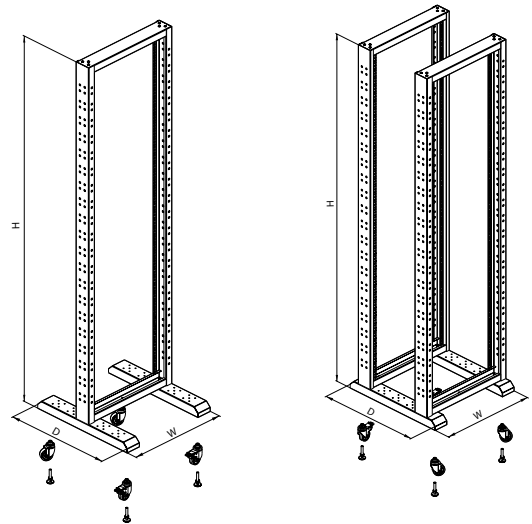

COLOR SAMPLER:  RAL 9005

## DESCRIPTION:

- |   |  |  |
|---|--|--|
| <p><b>Sizes</b></p> <ul style="list-style-type: none"> <li>• Height: 27, 36, 42, and 45U</li> <li>• Width: 559 mm</li> <li>• Depth: 600 mm (base size)</li> </ul> <p><b>Construction</b></p> <ul style="list-style-type: none"> <li>• 2.0 mm sheet steel</li> </ul> | <p><b>Load rating</b></p> <ul style="list-style-type: none"> <li>• 200 kg – two-post frame</li> <li>• 400 kg – four-post frame</li> </ul> <p><b>IP rating</b></p> <ul style="list-style-type: none"> <li>• IP00 (no protection)</li> </ul> | <p><b>Colors</b></p> <ul style="list-style-type: none"> <li>• Standard RAL 9005</li> </ul> <p><b>Base</b></p> <ul style="list-style-type: none"> <li>• Composed of sheet steel</li> <li>• Equipped with feet</li> <li>• Optional castors (to be ordered separately)</li> </ul> |
|---|--|--|

# ACCESORIES FOR RS FRAMES

## CROSS-RAIL FOR FOUR-POST FRAMES



- Used for fixing four-post frame
- 2 mm sheet steel
- Color: powder-coated RAL (standard RAL 9005)
- Package includes: 2× cross rails, 12× screw M5×12

Code	Description	Package
RSSD-RAIL	Cross-rail for four-post frame	1 pair

## WIRE-MANAGEMENT PANEL FOR FOUR-POST FRAMES

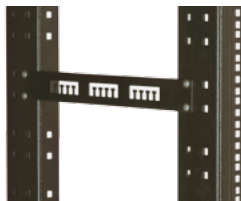

- Store and secure cables between two pairs of 19" vertical extrusions (four-post frame)
- 1,5 mm sheet steel
- Color: powder-coated RAL (standard RAL 9005)
- Package includes: 1× wire management panel

Code	Description	Package
RSSD-VP	Wire management panel for four-post frame	1 piece

## STABILIZER FOR TWO-POST AND FOUR-POST FRAMES

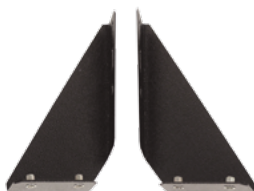

- Increases sturdiness and stability of RS open frames
- Package includes: 1× left + 1× right stabilizer, 8× screws M5, 4× nuts M5

Code	Description	Package
RSSD-BRACE	Stabilizer for two and four-post frame	1 pair

# SPACE OPTIMIZATION SECTIONS



End-of-the-row section applied



Front/rear sections applied

➤ **Conteg's Space Optimization Sections** are designed to provide your data center with additional layout flexibility.

## MAIN ADVANTAGES

- Special sections for adding extra space
- Allow layout flexibility via expansion of previously installed racks
- Same size as racks for minimal space consumption
- Can be added to the side, front and/or rear of standard racks

Space optimization sections	Compatible racks
ROF-ES-42-30/80	Ri7/RDF/RSF-42-xx/80
ROF-ES-45-30/80	Ri7/RDF/RSF-45-xx/80
ROF-ES-42-30/100	Ri7/RDF/RSF-42-xx/100
ROF-ES-45-30/100	Ri7/RDF/RSF-45-xx/100
ROF-RS-42-60/30	RSF/Ri7
ROF-RS-45-60/30	RSF/Ri7
ROF-RS-42-80/30	RDF/RSF/Ri7
ROF-RS-45-80/30	RDF/RSF/Ri7

## DESCRIPTION:

### SPACE OPTIMIZATION SECTIONS

- Compatible with RSF, RDF, Ri7 and RM7 series (iSEVEN - different front top shape)
- Expansion of both existing and new solutions – ready for next decade

### FRONT and REAR SECTION

- Increase usable depth by 300 mm modules
- Can be fitted out with extrusions
- Can be used for power management

### END-OF-ROW SECTION

- Additional space for infrastructure use with wide 300 mm module
- Can be used for power management



## END-OF-THE-ROW SECTION

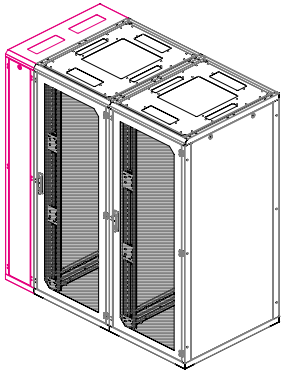

End-of-the-row section

- For cable management, patching and power distribution at end of cabinet row
- Frame design
- Front and rear panels with locks, no side panels
- Cable entries in top and bottom covers
- Accepts vertical cable management systems (e.g. perforated flat panels, basket trays)
- Package includes: 1x rack, 1x DP-DR-UNI, 4x feet

Code	H (in U)	Dimensions (mm)		Compatible racks
		W	D	
ROF-ES-42-30/80	42	300	800	RSF*, RDF*, R17, RM7
ROF-ES-42-30/100	42	300	1000	
ROF-ES-45-30/80	45	300	800	
ROF-ES-45-30/100	45	300	1000	

\* Optimized

## FRONT/REAR SECTION

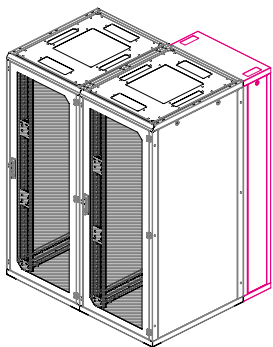

Front/rear section

- Expands available space at rear/front of rack, allowing for installation of deeper equipment
- Further possibility for patching and power distribution
- Cable entries in top and bottom covers
- Tinted glass door with swivel handle; full range of RSF family door options (security glass, sheet steel, perforated sheet steel, vented, active vented, etc.)
- Accepts 19" vertical extrusions or vertical cable management systems
- Package includes: 1x rack with glass door, 1x DP-DR-UNI, 4x feet

Code	H (in U)	Dimensions (mm)		Compatible racks
		W	D	
ROF-RS-42-60/30	42	600	300	RSF, RDF, R17, RM7
ROF-RS-45-60/30	45	600	300	
ROF-RS-42-80/30	42	800	300	
ROF-RS-45-80/30	45	800	300	

## RELATED ACCESSORIES

Code	Description	Note
DP-RS-VP-42/30/19-A	(H) 42U, (W) 300 mm, 9x 19" positions	VERTICAL PANELS FOR FRONT/REAR SECTIONS – vertical panels required for installing relevant 19" and 10" equipment (patch panels, PDUs, switches) and 14 or 15 RJ-45 panels in the front/rear section
DP-RS-VP-45/30/19-A	(H) 45U, (W) 300 mm, 9x 19" positions	
DP-RS-VP-42/30/10-A	(H) 42U, (W) 300 mm, 24x 10" positions	
DP-RS-VP-45/30/10-A	(H) 45U, (W) 300 mm, 24x 10" positions	
DP-RS-VP-42/30/RJ-A	(H) 42U, (W) 300 mm, 14x positions for RJ-45 panels, 6xRJ-45 modules each panel	
DP-RS-VP-45/30/RJ-A	(H) 45U, (W) 300 mm, 15x positions for RJ-45 panels, 6xRJ-45 modules each panel	
DP-RS-RJ-14-XX	14 empty panels for snap in, 6x RJ-45 modules each; check with sales for compatibility of the respective RJ-45 brand	
DP-ES-VP-42/30/19-A	(H) 42U, (W) 300 mm, 9x 19" positions	
DP-ES-VP-45/30/19-A	(H) 45U, (W) 300 mm, 9x 19" positions	

# FREE-STANDING RACKS

## 19" EXTRUSIONS

➤ A unique combination of 19" extrusions, with many advantages.

### MAIN ADVANTAGES

- Strong, stable system
- Slidable throughout entire rack depth
- Wide extrusions with additional positions

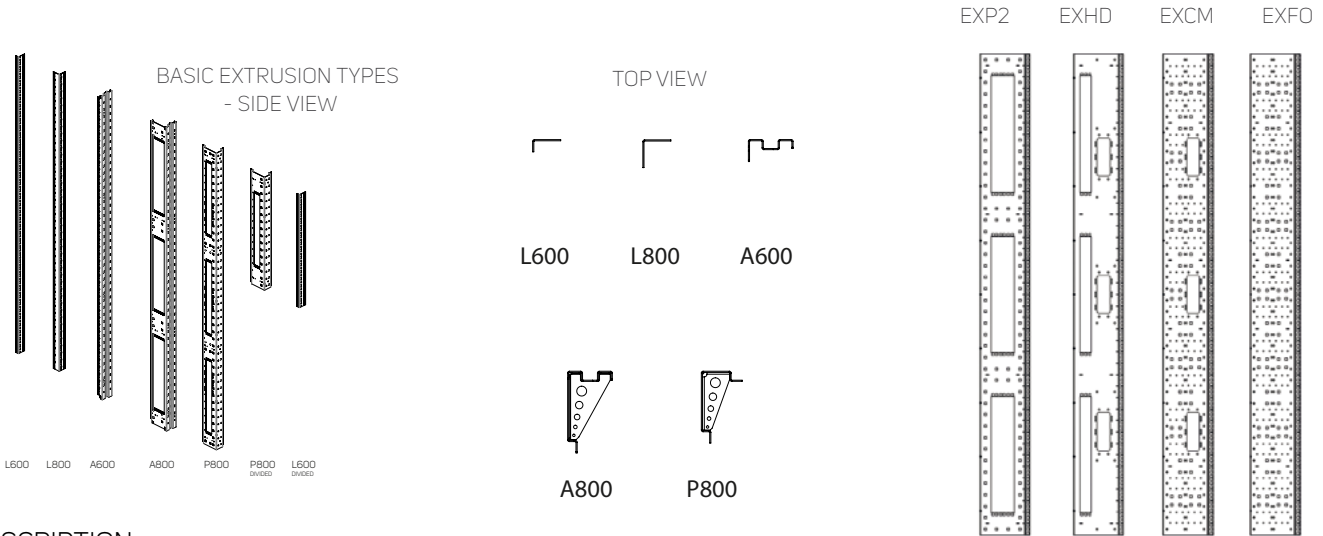

### DESCRIPTION

STANDARD EXTRUSIONS	
Type	Description
L	L-profile extrusions guarantee maximum compatibility with server mounting kits, making installation even easier. L-type extrusions standard in 600 mm and 800 mm wide racks. Vertical holders used for 800 mm wide racks.
A	A-type extrusions without horizontal holders; for 800 mm provide additional 24U (3× 2U 19") of installation space – valid for racks 42U and taller, adjustable from inside.
P	P-Type extrusions for 800 mm wide RSF racks. Extrusion a single continuous piece, each with three 3U, 19" vertical mounting positions. Additional 12U mounting positions can be used for structured cabling, active components, or filled with optional blank panels for future use.

ECCENTRIC EXTRUSIONS	
Type	Description
EXP2	Space for patch panels, PDUs and switches
EXHD	Combination space for patch panels, PDUs, switches and vertical HDWM -VMR-12/10F
EXCM*	Space for HDWM-VMR-12/10F and individual cable management
EXFO*	Universal space for individual cable management

Possible to install in racks: RDF; RSF 800 mm width only with U type extrusions supported for 42U and 45U racks. One pair of 19" vertical extrusions included; the opposite is always an L-profile extrusion.

\* EXCM and EXFO extrusions are compatible with HDWM-FSS-50 and HDWM-FSS-100

### ORDERING INFORMATION FOR ECCENTRIC EXTRUSIONS

All Conteg racks listed in the product catalog come with industry standard extrusions. To order custom solutions using Eccentric Extrusions, start by ordering a rack without extrusions. To do this, simply place an 'X' in the last position (normally used to indicate rack depth) in the ordering code matrix, followed by the code for the extrusion part you've selected. The following are some examples of correct part numbers for 42U racks: ROF-LV-42/8X-EXP2, ROF-LV-42/8X-EXHD, ROF-LV-42/8X-EXCM or ROF-LV-42/8X-EXFO.

It is always necessary to order two extrusion packages: one for the front, and one for the rear. Different combinations of front and rear extrusion positions are possible. Eccentric rack extrusions can be installed by simply ordering the extrusion (mentioned above), removing the existing parts and installing the new extrusions.

### COMPONENTS FOR COVERING HOLES IN EXTRUSIONS

DP-EHC-1000 – Set of covers for 9.5 mm holes, packaged in sets of 1000 pcs each.



02

WALL-MOUNT  
& SOHO RACKS



<b>PREMIUM RUN</b>	51
<b>PREMIUM Split RUD</b>	52
<b>iSEVEN REN</b>	53
<b>SOHO In-Wall ACP</b>	54
<b>SOHO On-Wall ACP</b>	55
<b>SOHO Mini REH 10" RACKS</b>	56
SOHO Mini REH Accessories	57
10" Fiber-optic Splice Boxes	57

Comparison	WALL MOUNT RACK SERIES			
	RUN	RUD	REN	ACP
	Welded-frame	Welded-frame	Welded-frame	Welded-frame
	Assembled	Assembled	Assembled	Assembled
	1.25 and 1.5 mm sheet steel	1.25 and 1.5 mm sheet steel	1 and 1.5 mm sheet steel	1.5 and 2 mm sheet steel
See page 51	See page 52	See page 53	See page 54	
<b>Appropriate use</b>				
Cable rack	+++	+++	+++	+++
IT systems	+++	+++	+	+
Distribution point	+++	+++	+++	+++
Lockable side panels	+++	+++	-	-
<b>Balanced load rating</b>				
Up to 20 kg	-	-	yes	yes
Up to 30 kg	yes	-	-	-
Up to 40 kg	yes	yes	-	-
<b>IP rating</b>				
IP30	yes	yes	yes	yes
<b>Size</b>				
6U	yes	yes	yes	yes
9U	yes	yes	-	-
10U	-	-	yes	-
12U	yes	yes	yes	-
15U	yes	yes	yes	-
18U	yes	yes	-	-
<b>Depth</b>				
300 mm	-	-	yes	-
400 mm	yes	-	yes	-
500 mm	yes	yes	yes	-
600 mm	yes	-	-	-
<b>Colors</b>				
Light gray RAL 7035	yes	yes	yes	yes
<b>Locking system</b>				
Singlepoint	yes	yes	yes	yes
Side panel locks	yes	yes	-	-

General comparison of IT rack series; for technical details see appropriate catalog pages.



# WALL-MOUNT & SOHO RACKS

## PREMIUM RUN



RUN-09-60/40

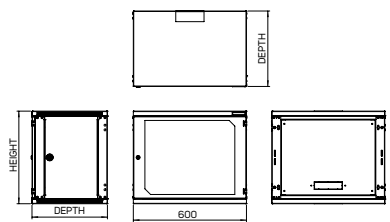
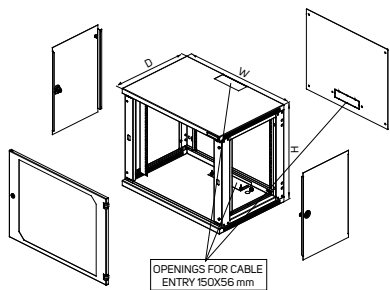

COLOR SAMPLER:  RAL 7035

### DESCRIPTION:

#### Sizes

- Height: 6, 9, 12, 15, 18U
- Width: 600 mm
- Depth: 400, 500 or 600 mm

#### Construction

- 1.25 mm sheet steel

#### Load rating

- Standard 40 kg (depth 400 and 500 mm), standard 30 kg (depth 600 mm)

#### IP rating

- Standard IP30

#### Colors

- Standard RAL 7035

➤ Wall-Mount PREMIUM RUN racks are designed for wall-mount installation with extended access.

### MAIN ADVANTAGES

- Excellent rigidity
- Unobstructed access to installed equipment from front and sides
- Lockable side panels

#### PREMIUM RUN – LOAD RATING 30 KG

Code	H (in U)	Dimensions (mm)				Dimensions including packing (mm)			Gross weight (kg)
		H	W	D	Useful depth	H	W	D	
RUN-06-60/60	6	358	603	600	580	378	620	630	20
RUN-09-60/60	9	491	603	600	580	510	620	630	26
RUN-12-60/60	12	624	603	600	580	645	620	630	29
RUN-15-60/60	15	758	603	600	580	778	620	630	33
RUN-18-60/60	18	891	603	600	580	910	620	630	39

#### PREMIUM RUN – LOAD RATING 40 KG

Code	H (in U)	Dimensions (mm)				Dimensions including packing (mm)			Gross weight (kg)
		H	W	D	Useful depth	H	W	D	
RUN-06-60/40	6	358	600	400	380	378	620	430	16
RUN-09-60/40	9	491	600	400	380	510	620	430	20
RUN-12-60/40	12	624	600	400	380	645	620	430	23
RUN-15-60/40	15	758	600	400	380	778	620	430	27
RUN-18-60/40	18	891	600	400	380	910	620	430	33
RUN-06-60/50	6	358	600	500	480	378	620	530	18
RUN-09-60/50	9	491	600	500	480	510	620	530	23
RUN-12-60/50	12	624	600	500	480	645	620	530	26
RUN-15-60/50	15	758	600	500	480	778	620	530	30
RUN-18-60/50	18	891	600	500	480	910	620	530	36

#### Front door

- Tinted security-glass (EN 12150-1) or sheet steel door
- Reversible door – easy to re-hang for opening right or left
- Door opening angle 180°

#### Rear panel

- Removable, with module for cable entry
- When installed without rear panel, additional holes exposed for installation of 19" components
- Mounting holes for wall installation on back

#### Cable entries

- Top and bottom openings for cable entry, size 150×56 mm
- Covered by sliding blank panel with butterfly nuts (DP-DB-200×68)

- Variable openings in relation to number of cables entering rack
- Cable entries on rear edge of enclosure for straight cable path alongside wall

#### Other

- Drilling template
- Extra pair of DP-LV-N-xx extrusions optional

### STANDARD CONFIGURATION:

- 1 pair sliding 19" vertical extrusions
- 2 removable side panels with lock
- Tinted security-glass door (EN 12150-1) with lock
- GND/earthing kit
- 16 mounting kits

Note: All dimensions in mm



# PREMIUM SPLIT RUD



RUD-15-60/50

COLOR SAMPLER:  RAL 7035

➤ Wall-Mount PREMIUM Split RUD racks are designed for wall-mount installation with easy access.

## MAIN ADVANTAGES

- Designed for excellent rigidity
- Free access to installed equipment from front, rear and sides
- Lockable side panels
- Lockable rear section

Code	H (in U)	Dimensions (mm)				Dimensions including packing (mm)			Gross weight (kg)
		H	W	D	Useful depth	H	W	D	
RUD-06-60/50	6	358	600	500	490	378	620	530	20
RUD-09-60/50	9	491	600	500	490	510	620	530	24
RUD-12-60/50	12	624	600	500	490	645	620	530	28
RUD-15-60/50	15	758	600	500	490	778	620	530	32
RUD-18-60/50	18	891	600	500	490	910	620	530	40

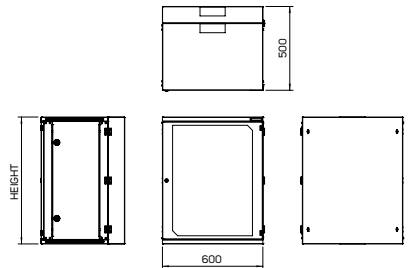
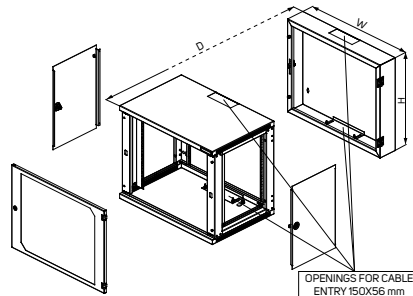

## DESCRIPTION:

### Sizes

- Height: 6, 9, 12, 15, 18U
- Width: 600 mm
- Depth: 500 mm

### Construction

- 1.25 mm sheet steel

### Load rating

- Standard 40 kg (balanced load)

### IP rating

- Standard IP30

### Colors

- Standard RAL 7035

### Front door

- Tinted security-glass (EN 12150-1) or sheet steel door
- Reversible door – easily re-hangs to open right or left
- Door opening angle 180°

### Rear module

- Removable, with module for cable entry
- When installed without rear panel, additional holes exposed for installation of 19" components
- Mounting holes for wall installation on back

### Cable entries

- 150x56 mm top and bottom openings
- Covered by sliding blank panel with butterfly nuts (DP-DB-200x68)

- Variable openings in relation to number of cables entering rack
- Cable entries on rear edge of enclosure for straight cable path alongside the wall

### Other

- Drilling template
- Extra pair of DP-LV-N-xx extrusions optional

## STANDARD CONFIGURATION:

- 1 pair sliding 19" vertical extrusions
- 2 removable side panels with lock
- Tinted security-glass door (EN 12150-1) with lock
- GND/earthing kit
- 16 mounting kits

Note: All dimensions in mm

# iSEVEN REN



REN-10-60/40

COLOR SAMPLER:  RAL 7035

➤ **Wall-Mount iSEVEN REN** racks are ready for daily use, with an unmatched ratio between price, utility value and quality.

## MAIN ADVANTAGES

➤ Easy access to installed equipment via front door

Code	H (in U)	Dimensions (mm)				Dimensions incl. packing (mm)			Gross weight (kg)
		H	W	D	Useful depth	H	W	D	
REN-06-60/30	6	332	530	300	250	350	555	339	9
REN-06-60/40	6	332	530	400	350	350	555	439	10
REN-10-60/40	10	510	530	400	350	535	555	439	12
REN-12-60/40	12	599	530	400	350	655	555	439	15.5
REN-15-60/40	15	732	530	400	350	758	555	439	16
REN-06-60/50	6	332	530	500	450	350	555	539	12
REN-10-60/50	10	510	530	500	450	535	555	539	17
REN-12-60/50	12	599	530	500	450	655	555	539	18
REN-15-60/50	15	732	530	500	450	758	555	539	21

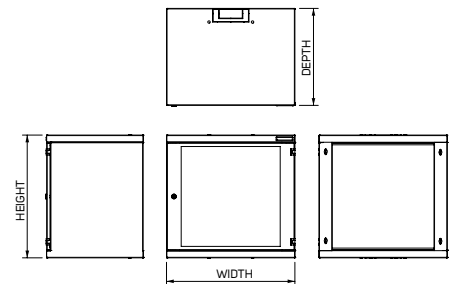
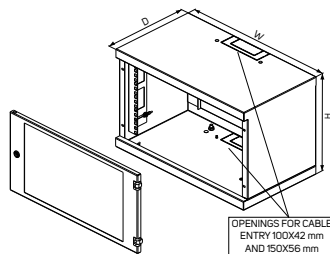

## DESCRIPTION:

- Sizes**
- Height: 6, 10, 12, 15U
  - Width: 530 mm
  - Depth: 300, 400 or 500 mm
- Construction**
- 1 mm sheet steel
- Load rating**
- Standard 20 kg balanced load
- IP rating**
- Standard IP30

- Colors**
- Standard RAL 7035
- Front door**
- Tinted security-glass (EN 12150-1) or sheet steel door
  - Reversible door – easy re-hanging to open right or left (at installation site)
  - Door opening angle 180°
- Cable entries**
- Top and bottom openings for knock-out cable entry, size 100×42 mm and 150×56 mm

- Cable entries on rear edge of enclosure for straight cable path alongside wall
- Other**
- Drilling template

## STANDARD CONFIGURATION:

- 1 pair sliding 19" vertical extrusions
- Tinted security-glass door (EN 12150-1) with lock
- GND/earthing kit

Note: All dimensions in mm

# SOHO IN-WALL ACP



ACP-IW-55/53/14

COLOR SAMPLER:  RAL 7035

➤ **ACP series SOHO** racks are designed for households and small offices. They are the only racks in the Conteg portfolio that can be installed directly into the wall, making them an ideal solution for use within a space-constrained environment.

## MAIN ADVANTAGES

- Equipped with extrusions for both active equipment installation (2U) and mounting passive components (4U)
- Offers access to installed equipment through front door

Code	Box dimensions (mm)			Vertical extrusions		Horizontal extrusions		External dimensions including packing (mm)			Gross weight (kg)
	H	W	D	U *	UD **	U *	UD **	H	W	D	
ACP-IW-55/53/14	550	530	140	4	90	2	300	630	595	170	12

\* Length of extrusions in units

\*\* Max. depth of installed equipment in mm

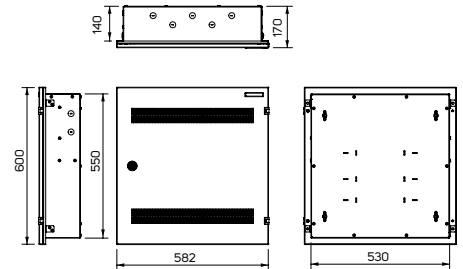
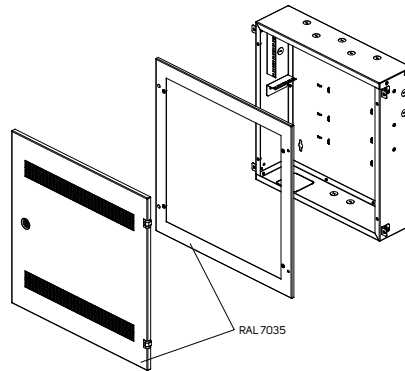

## DESCRIPTION:

### Sizes

- Height: 550 mm
- Width: 530 mm
- Depth: 140 mm

### Construction

- Zinc-coated 1.25, 1.5, and 2 mm sheet steel box

### Colors

- Standard RAL 7035

### Load rating

- 20 kg

### Front door

- Door opening angle 180°
- Perforated door for effective ventilation with lock

### Cable entries

- Knock-out at bottom for internal electrical outlet
- Multiple 22.6 mm conduit knock-outs on all sides of box
- Cable tie bump outs on rear side of box

## STANDARD CONFIGURATION:

- 1 pair of fixed 19" horizontal extrusions (2U)
- 1 pair of fixed 19" vertical extrusions (4U)
- Sheet steel perforated door with lock

Note: All dimensions in mm

# SOHO ON-WALL ACP



ACP-OW-55/53/14

➤ **SOHO On-Wall ACP** racks are installed directly on the wall. This distribution enclosure gives great deployment flexibility, while offering a more aesthetically pleasing and cost-effective solution to the developer/homeowner.

## MAIN ADVANTAGES

- Equipped with extrusions for both active equipment installation (2U) and mounting passive components (4U)
- Offers access to installed equipment through front door

COLOR SAMPLER: RAL 7035

Code	Box dimensions (mm)			Vertical extrusions		Horizontal extrusions		External dimensions including packing (mm)			Gross weight (kg)
	H	W	D	U *	UD **	U *	UD **	H	W	D	
ACP-OW-55/53/14	550	530	155	4	90	2	300	630	595	170	12

\* Length of extrusions in units

\*\* Max. depth of installed equipment in mm

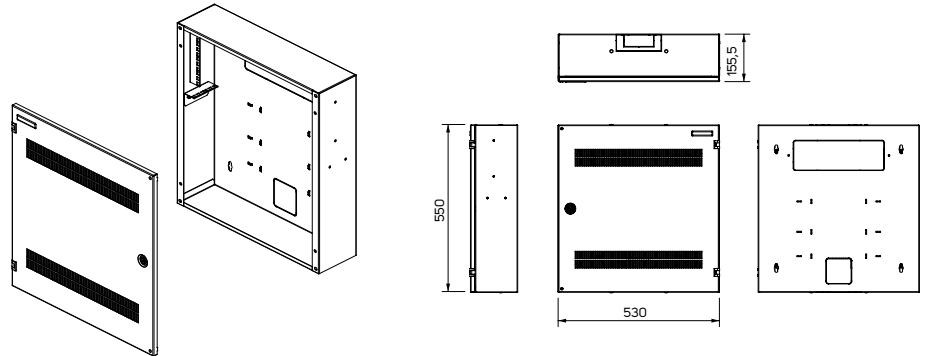

## DESCRIPTION:

### Sizes

- Height: 550 mm
- Width: 530 mm
- Depth: 155 mm

### Construction

- Box and door made of 1.25, 1.5, and 2 mm sheet steel

### Colors

- Standard RAL 7035

### Load rating

- 20 kg

### Front door

- Door opening angle 180°
- Perforated door for effective ventilation with lock

### Cable entries

- Knock-out at bottom for internal electrical outlet
- Multiple 22.6 mm conduit knock-outs on all sides of box
- Cable tie bump outs on rear side of box

## STANDARD CONFIGURATION:

- 1 pair of fixed 19" horizontal extrusions (2U)
- 1 pair of fixed 19" vertical extrusions (4U)
- Sheet steel perforated door with lock

Note: All dimensions in mm

# SOHO MINI REH 10" RACKS



REH-06-30/26

COLOR SAMPLER:  RAL 7035

➤ **SOHO Mini REH** racks are suitable for the placing of 10" patch panels, shelves, SOHO active components, etc.

## MAIN ADVANTAGES

- Minimal dimensions allow installation in small offices and households
- Offers access to installed equipment through front door

Code	H (in U)	Dimensions (mm)				Dimensions including packing (mm)			Gross weight (kg)
		H	W	D	Useful depth	H	W	D	
REH-04-30/26	4	237	300	260	230	257	317	287	4.5
REH-06-30/26	6	326	300	260	235	346	317	287	5.5
REH-09-30/26	9	459	300	260	235	477	317	287	7

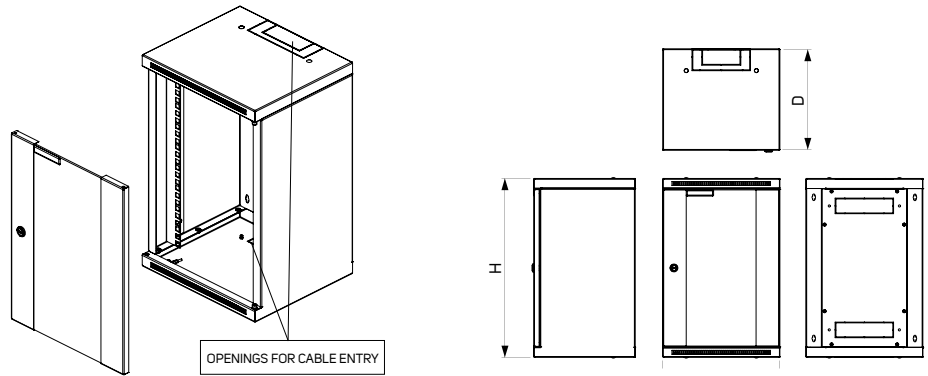

## DESCRIPTION:

### Sizes

- Height: 4, 6 and 9U
- Width: 300 mm
- Depth: 260 mm

### Construction

- 1.25 mm sheet steel

### Load rating

- Standard 20 kg balanced load

### IP rating

- Standard IP30

### Colors

- Standard RAL 7035

### Front door

- Tinted security-glass (EN 12150-1)
- Reversible door – easily re-hangs to open on right or left (at installation site)
- Door opening angle 180°

### Cable entries

- Knock-out top and bottom openings for 150x56 mm cable entry; 150x56 mm rear cable entry; openings can also be covered with blank panel (DP-DB-200x68) or brush (DP-KP-KAR3)
- Cable entries start on rear edge of enclosure for straight cable path alongside wall

### Other

- One pair of 10" vertical extrusions; can be moved back up to 20 mm
- Drilling template
- Mounting holes on back for wall installation

## STANDARD CONFIGURATION:

- 1 pair of 10" vertical extrusions
- Tinted security glass door (EN 12150-1) with lock
- Openings for cable entry
- 8 mounting kits

## SOHO MINI REH ACCESSORIES



DP-MP-S1U

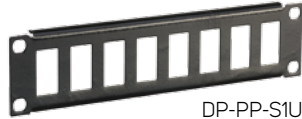

DP-PP-S1U

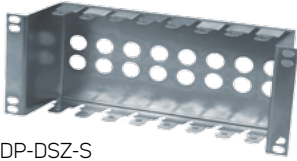

DP-DSZ-S



DP-PT-S200



DP-ZA-S1U



DP-S01-VENT



DP-VP-PS01

REH – PATCH PANELS				
Code	H (in U)	W	Used with	Package
DP-PP-S1U	1	10"	8 Keystone type modules with DP-KEY; 16.7x24.3 mm standard hole size	1 pc
DP-MP-S1U	1	10"	12 modules Panduit	1 pc
DP-DSZ-S	2+1/2	10"	8 modules LSA-PLUS	1 pc

REH – ACCESSORIES				
Code	H (in U)	W	Description	Package
DP-PT-S200	1	10"	150 mm deep shelf	1 pc
DP-ZA-S1U	1	10"	Blank panel	1 pc
DP-S01-VENT	1	10"	Vented panel	1 pc
DP-VP-PS01	1	10"	Wire management panel with plastic brackets	1 pc

## 10" FIBER-OPTIC SPLICE BOXES



ORMS-01

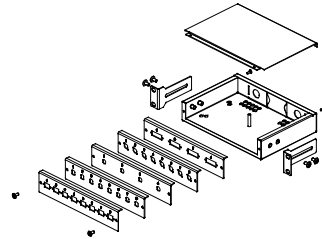

- For use with modular front panel
- Up to 8 positions: ST, SC or FC type or 4 positions DSC or FCD type
- Height: 1U
- Cable entry via two PG9 couplings on rear part (included)
- Holes not in use can be covered
- Installation in 10" rack with two sliding holders
- Installation kit for splice cassette size 142x95 mm (included)
- Color: powder-coated RAL (standard RAL 9005)
- Package includes: 1x fiber optic box, 2x holder for 10" rack, 2x PG9 couplings, 2x screws for affixing to front panel (front panel not included)

Code	Description	H (in U)	W	D (mm)	Package
ORMS-01	10" fiber-optic splice boxes	1	10"	160	1 pc
FRONT PANELS					
ORS-08ST	Modular front panel	1	10"	–	1 pc
ORS-08SC	Modular front panel	1	10"	–	1 pc
ORS-04DSC	Modular front panel	1	10"	–	1 pc
ORS-08FC	Modular front panel	1	10"	–	1 pc
ORS-04FCD	Modular front panel	1	10"	–	1 pc





03

CABLE  
MANAGEMENT



<b>High Density Wire Management (HDWM)</b>	60
Front Duct System Compatible with Vertical HDWM	61
Vertical HDWM	62
Horizontal HDWM	63
Adjustable Cable Through for Vertical HDWM	64
<b>Optiway Optical Pathway System</b>	65
Main Duct, Joiner, Cross	66
Reducer, Tee, Horizontal Elbow	67
Vertical Inside Elbow, Spillover	68
Vertical Outside Elbow, Trumpet, End Cap, Spillover Support Bracket	69
Threaded Rod Attachment Bracket	70
Threaded Rod Mounting Brackets	70
<b>Top Duct</b>	71
Top Duct – Cross Connection, Accessories	72
Supporting Brackets	73
<b>Standard Cable Management</b>	74
19" Wire Management Panels with Plastic Brackets, Plastic Cable Brackets	74
19" Wire Management Panels with Plastic Ducts, Wire Management Panels with Metal Brackets, Metal Cable Brackets	75
Vertical Wire Management Panels and Cable Bracket Holders, Vertical Wire Management Panels, Horizontal Cable Tray and Side Cable Management Holders, Side Cable Perforated Panels for A-type Extrusions	76
Cable Basket Trays, Side Cable Perforated Panels, Side Cable Grids	77



# HIGH DENSITY WIRE MANAGEMENT

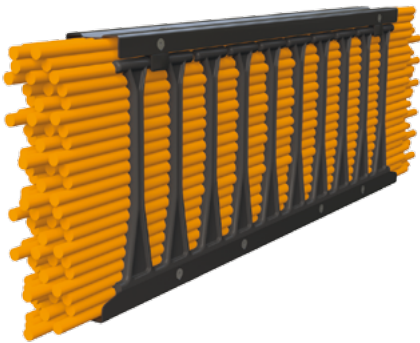

➤ **High Density Wire Management (HDWM)** helps to improve network performance and reliability (system under industrial trademark).

## MAIN ADVANTAGES

- Reduces risk of attenuation and substantially increases data transmission reliability
- Solution for racks and open frames
- Innovative approach for backbone and patch cables allow better organization in accordance with industry standards and major cable manufacturer recommendations
- New design for 48 patch cords (Cat. 7A) in 1U position
- Unbeatable density of patch cords
- Bend radius control
- Allows installation of up to 2016 patch cords in one rack
- Unique front panel latching system
- Front or front/rear design layout available
- Wide range of sizes usable for typical applications

COLOR SAMPLER:  RAL 9005

HIGH DENSITY WIRE MANAGER CABLE FILL CALCULATOR						
Code	Description	Cable Details	Number of Cables			
			Cat. 6 UTP	Cat. 6A UTP	Cat. 7A PIMF	Custom
		Ø (mm)	5.870	7.239	7.620	8.000
		Fill Factor	50 %			
<b>STANDARD VERSION</b>						
HDWM-HM-1F	Horizontal HDWM, 1U×10 finger, front only 1U×19"×112 mm		50	33	30	27
HDWM-VMR-42-12/10F	Vertical High Density Rack Wire Manager, 41 fingers, front only, 42U×100×112 mm		184	121	109	99
HDWM-VMF-42-15/20F	Vertical High Density Frame Wire Manager, 41 fingers, front only, 42U×151×200 mm		507	333	301	273
HDWM-VMF-42-25/20F	Vertical High Density Frame Wire Manager, 41 fingers, front only, 42U×251×200 mm		913	600	541	491
HDWM-VMF-42-25/30F	Vertical High Density Frame Wire Manager, 41 fingers, front only, 42U×251×300 mm		1411	928	837	760
Finger Opening Standard	Capacity of finger opening - standard version		47	31	28	25
<b>LONGER VERSION</b>						
HDWM-HML-1F	Horizontal HDWM, 1U×10 long finger, front only 1U×19"×182mm		92	60	54	49
HDWM-VMR-42-19/10F	Vertical High Density Rack Wire Manager, 41 long fingers, front only, 42U×100×182 mm		312	205	185	168
HDWM-VMF-42-22/20F	Vertical High Density Frame Wire Manager, 41 long fingers, front only, 42U×221×200 mm		791	520	469	426
HDWM-VMF-42-32/20F	Vertical High Density Frame Wire Manager, 41 long fingers, front only, 42U×321×200 mm		1197	787	710	644
HDWM-VMF-42-32/30F	Vertical High Density Frame Wire Manager, 41 long fingers, front only, 42U×321×300 mm		1851	1217	1098	996
Finger Opening Long	Capacity of finger opening – longer version		92	60	54	49

## DESCRIPTION:

### Front/rear design

- Dual pathway for managing cables within the same HDWM
- Horizontal and vertical orientations, vertical racks (VMR) for front only

### Front only design

- Simple pathway for cables
- Available in horizontal and vertical orientations

### Horizontal orientation

- Horizontal pathway for managing cables between installed equipment

- For mounting onto 19" extrusions

### Vertical orientation

- Vertical pathway for managing cables into and through the rack or frame
- Velcro cable ties for optimum cable bundle management
- Vertical managers can be bolted together (front to back), customizing the HDWM to your requirements

### Frame vertical panel (VMF)

- 3 mm thick aluminum ensures high rigidity and structural strength
- Easy installation onto RSG frames

### Cable Troughs

- Allows cable management of cables between vertical rack (VMR) or frame (VMF) HDWM
- Adjustable length

### Sizes

- Fingers come in two sizes – standard and long

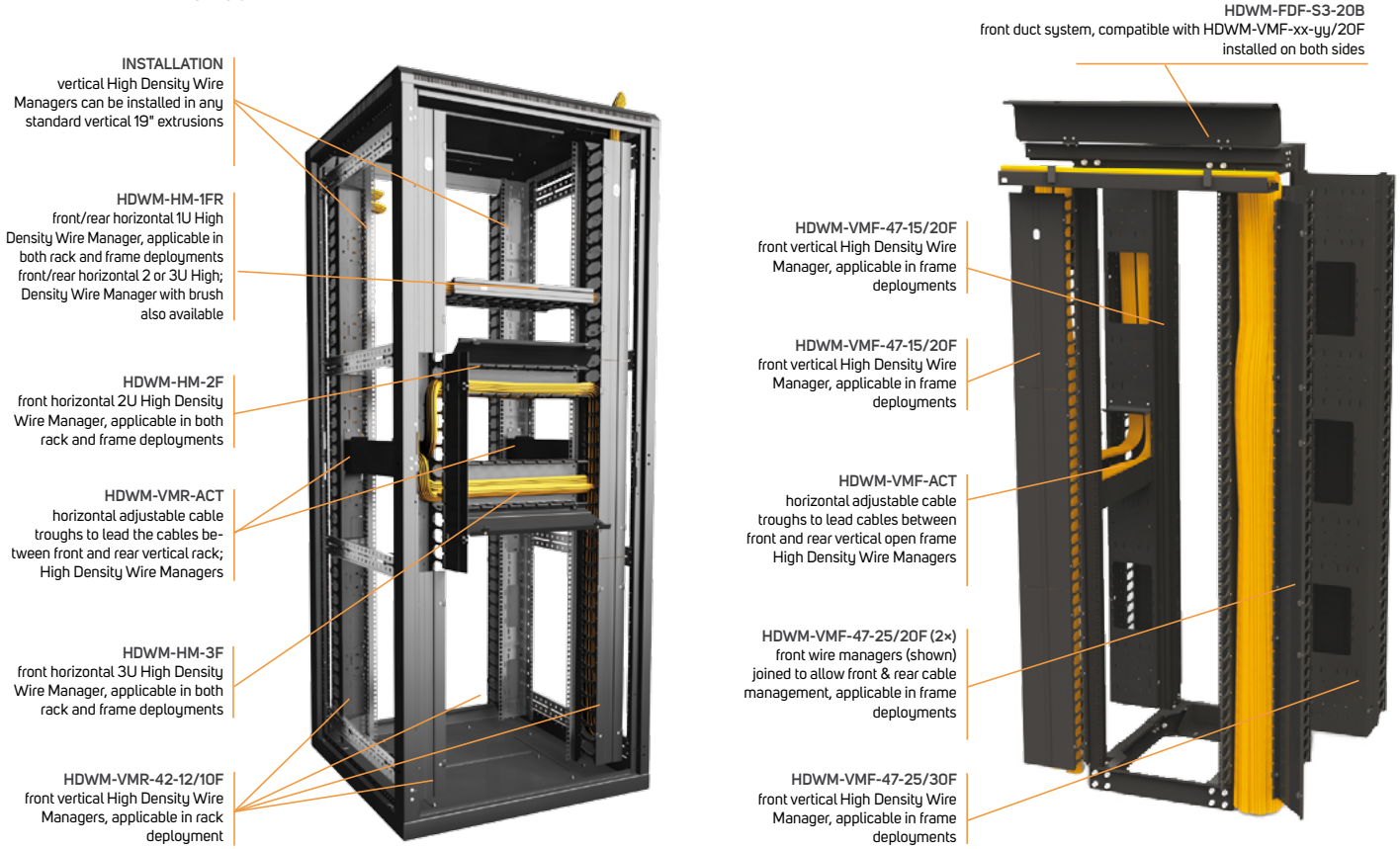

## FRONT DUCT SYSTEM COMPATIBLE WITH VERTICAL HDWM – RSG OPEN FRAME INSTALLATION

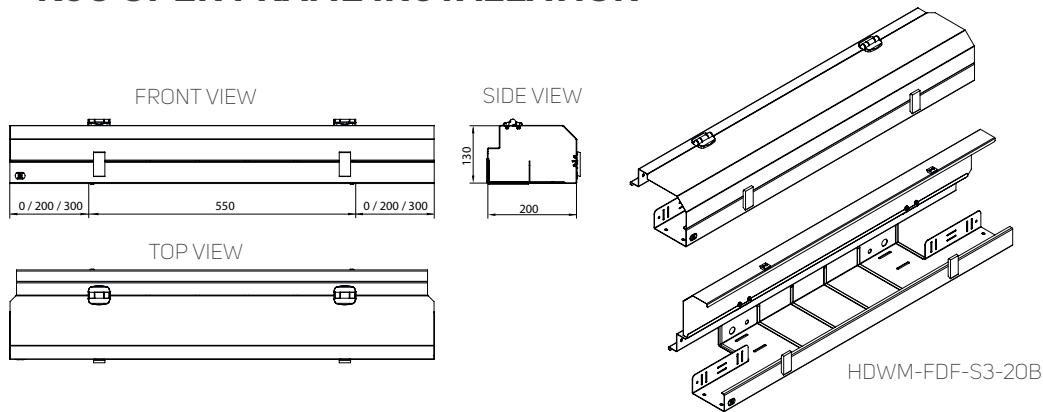

**Package includes:**

- Set 1: 1x HDWM front duct, 1x cable radius protector, 1x connecting module, 4x screws M5, 4x nuts M5, 4x washer M5
- Set 2: 1x HDWM front duct, 2x cable radius protector, 1x connecting module, 4x screws M5, 4x nuts M5, 4x washer M5

Note: All dimensions in mm

FRONT DUCT SYSTEM COMPATIBLE WITH VERTICAL HDWM			
Code	Installation	Description	Package
HDWM-FDF-S3-20L	Open frame	Front duct system, compatible with HDWM-VMF-xx-yy/20F installed on the left-hand side	1 pc of set 1
HDWM-FDF-S3-20R	Open frame	Front duct system, compatible with HDWM-VMF-xx-yy/20F installed on the right-hand side	1 pc of set 1
HDWM-FDF-S3-20B	Open frame	Front duct system, compatible with HDWM-VMF-xx-yy/20F installed on both sides	1 pc of set 2
HDWM-FDF-S3-30L	Open frame	Front duct system, compatible with HDWM-VMF-xx-yy/30F installed on the left-hand side	1 pc of set 1
HDWM-FDF-S3-30R	Open frame	Front duct system, compatible with HDWM-VMF-xx-yy/30F installed on the right-hand side	1 pc of set 1
HDWM-FDF-S3-30B	Open frame	Front duct system, compatible with HDWM-VMF-xx-yy/30F installed on both sides	1 pc of set 2
HDWM-FDF-S3-20L30R	Open frame	Front duct system, compatible with HDWM-VMF-xx-yy/20F installed on the left-hand side and HDWM-VMF-xx-yy/30F installed on the right-hand side	1 pc of set 2
HDWM-FDF-S3-30L20R	Open frame	Front duct system, compatible with HDWM-VMF-xx-yy/30F installed on the left-hand side and HDWM-VMF-xx-yy/20F installed on the right-hand side	1 pc of set 2
HDWM-FDF-S3-EC	Open frame	End cap for front duct system	2 pcs

# VERTICAL HIGH DENSITY WIRE MANAGERS

RACK & RSG OPEN FRAME INSTALLATION

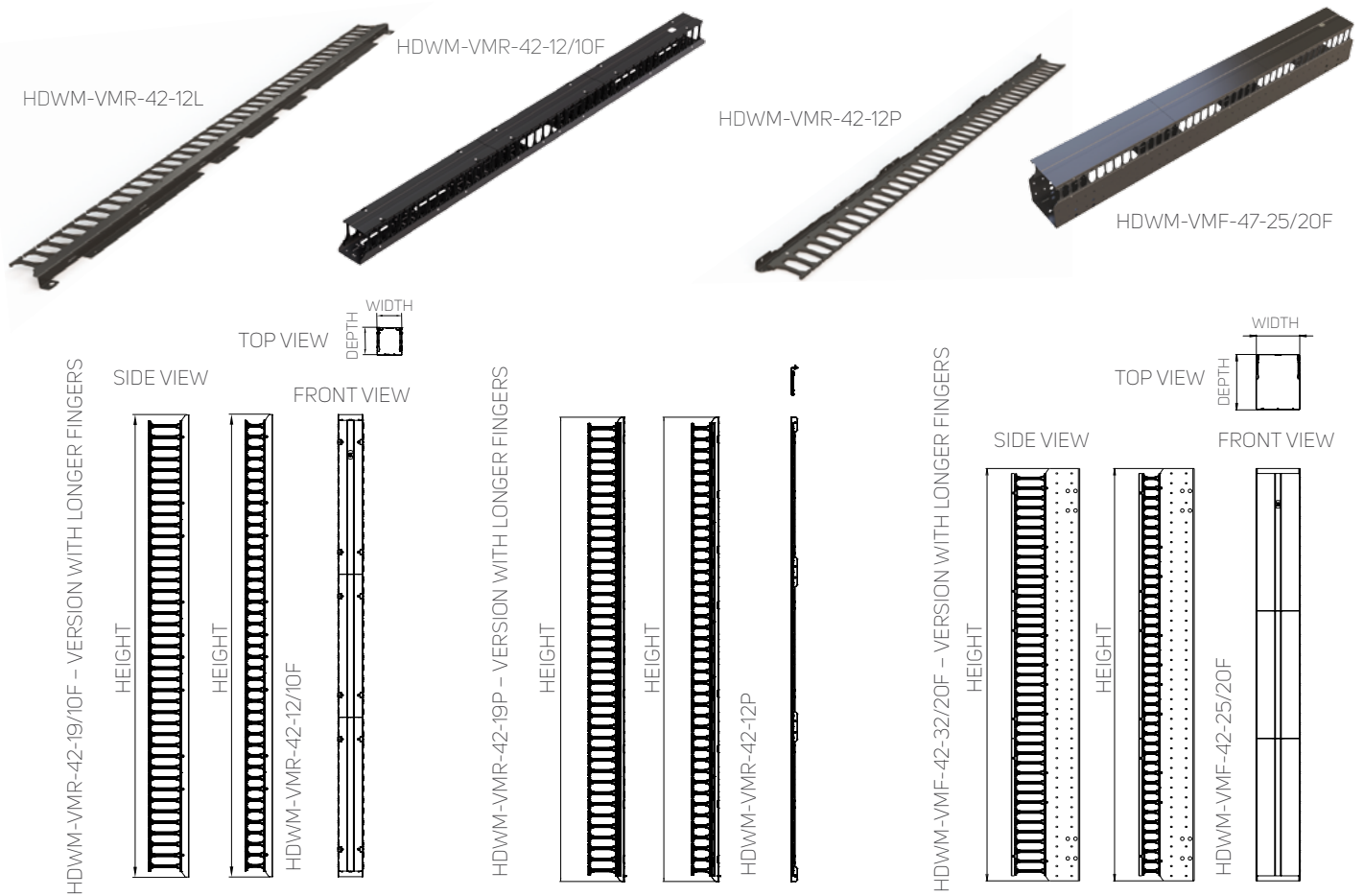

**Package includes:**

- Set 1: 1x HDWM manager, set of blanking panels, 8x screws M5, 8x nuts M5, 8x washer M5, 10x velcro ties HDWM-VCT
- Set 2: 1x HDWM manager, 4x screws M5, 4x nuts M5, 4x washer M5, 5x velcro ties HDWM-VCT
- Set 3: 1x HDWM manager, 4x screws M5, 4x nuts M5, 4x washer M5, 10x velcro ties HDWM-VCT

VERTICAL HIGH DENSITY WIRE MANAGERS										
Code	Installation	Type	No. of fingers		Dimensions			Extended version with longer fingers		Package
			Front	Rear	H (in U)	W (mm)	D (mm)	Code	D (mm)	
HDWM-VMR-42-12/10F	Rack	Front	41	x	42	100	112	HDWM-VMR-42-19/10F	182	1 pc of set 1
HDWM-VMR-45-12/10F	Rack	Front	44	x	45	100	112	HDWM-VMR-45-19/10F	182	
HDWM-VMR-48-12/10F	Rack	Front	47	x	48	100	112	HDWM-VMR-48-19/10F	182	
HDWM-VMR-42-12L	Rack	L-type extrusion and A-type RSF 600 mm width, one row	41	x	42	-	112	HDWM-VMR-42-19L	182	1 pc of set 2
HDWM-VMR-45-12L	Rack		44	x	45	-	112	HDWM-VMR-42-19P	182	
HDWM-VMR-48-12L	Rack		47	x	48	-	112	HDWM-VMR-45-19L	182	
HDWM-VMR-42-12P	Rack	P-type extrusion and A-type RSF 800 mm width, one row	41	x	42	-	112	HDWM-VMR-45-19P	182	1 pc of set 2
HDWM-VMR-45-12P	Rack		44	x	45	-	112	HDWM-VMR-48-19L	182	
HDWM-VMR-48-12P	Rack		47	x	48	-	112	HDWM-VMR-48-19P	182	
HDWM-VMF-42-15/20F	Open frame	Front <sup>1</sup>	41	x	42	200	151	HDWM-VMF-42-22/20F	221	1 pc of set 3
HDWM-VMF-45-15/20F	Open frame	Front <sup>1</sup>	44	x	45	200	151	HDWM-VMF-45-22/20F	221	
HDWM-VMF-47-15/20F	Open frame	Front <sup>1</sup>	46	x	47	200	151	HDWM-VMF-47-22/20F	221	
HDWM-VMF-42-25/20F	Open frame	Front <sup>1</sup>	41	x	42	200	251	HDWM-VMF-42-32/20F	321	
HDWM-VMF-45-25/20F	Open frame	Front <sup>1</sup>	44	x	45	200	251	HDWM-VMF-45-32/20F	321	
HDWM-VMF-47-25/20F	Open frame	Front <sup>1</sup>	46	x	47	200	251	HDWM-VMF-47-32/20F	321	
HDWM-VMF-42-25/30F	Open frame	Front <sup>1</sup>	41	x	42	300	251	HDWM-VMF-42-32/30F	321	
HDWM-VMF-45-25/30F	Open frame	Front <sup>1</sup>	44	x	45	300	251	HDWM-VMF-45-32/30F	321	
HDWM-VMF-47-25/30F	Open frame	Front <sup>1</sup>	46	x	47	300	251	HDWM-VMF-47-32/30F	321	

<sup>1</sup> For front/rear design, simply order respective front managers and install them easily at the installation site with enclosed hardware (standard). Both the standard and longer versions may be combined as well.

# HORIZONTAL HIGH DENSITY WIRE MANAGERS

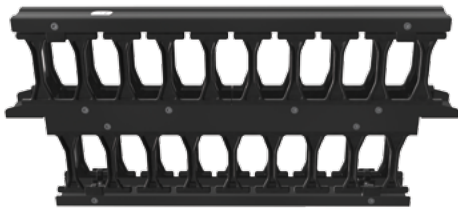

Front/rear design-  
HDWM-HM-1FR

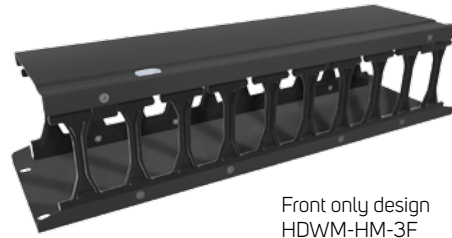

Front only design  
HDWM-HM-3F



HDWM-HML-1F

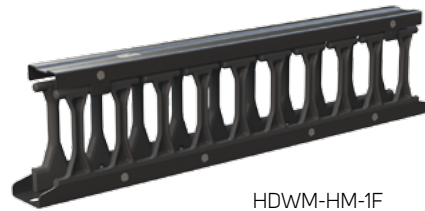

HDWM-HM-1F

FRONT/REAR

FRONT ONLY

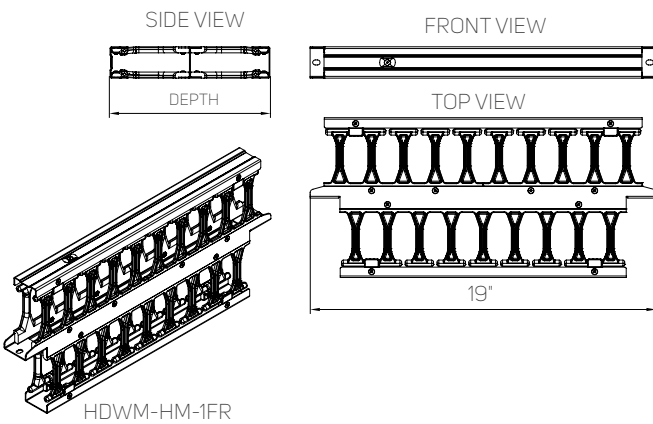

HDWM-HM-1FR

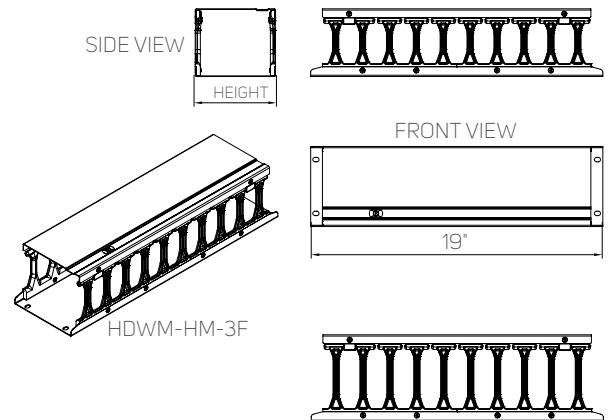

HDWM-HM-3F

TOP VIEW - VERSION WITH LONGER FINGERS

Package includes:

- HDWM manager, 1x DP-MO-01

## HORIZONTAL HIGH DENSITY WIRE MANAGERS

Code	Installation	Type	No. of fingers		Dimensions			Extended version with longer fingers		Package
			Front	Rear	H (in U)	W	D (mm)	Code	D (mm)	
HDWM-HM-1F	Open frame/rack	Front	10	x	1	19"	112	HDWM-HML-1F	182	1 pc
HDWM-HM-1FR	Open frame/rack	Front/rear	10	9	1	19"	223	HDWM-HML-1FR	363	1 pc
HDWM-HM-2F	Open frame/rack	Front	10	x	2	19"	112	HDWM-HML-2F	182	1 pc
HDWM-HM-2FR	Open frame/rack	Front/rear	10	9	2	19"	223	HDWM-HML-2FR	363	1 pc
HDWM-HM-2FRB	Open frame/rack	Front/rear, brush	10	9	2	19"	223	HDWM-HML-2FRB	363	1 pc
HDWM-HM-3F	Open frame/rack	Front	10	x	3	19"	112	HDWM-HML-3F	182	1 pc
HDWM-HM-3FR	Open frame/rack	Front/rear	10	9	3	19"	223	HDWM-HML-3FR	363	1 pc
HDWM-HM-3FRB	Open frame/rack	Front/rear, brush	10	9	3	19"	223	HDWM-HML-3FRB	363	1 pc



# ADJUSTABLE CABLE TROUGH FOR VERTICAL HDWM

## RSG OPEN FRAME INSTALLATION

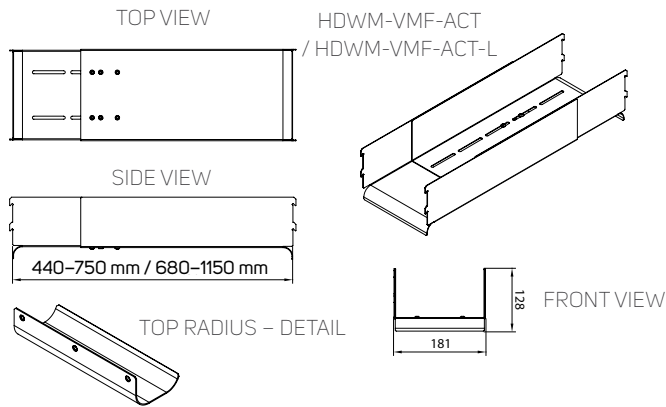

## RACK INSTALLATION

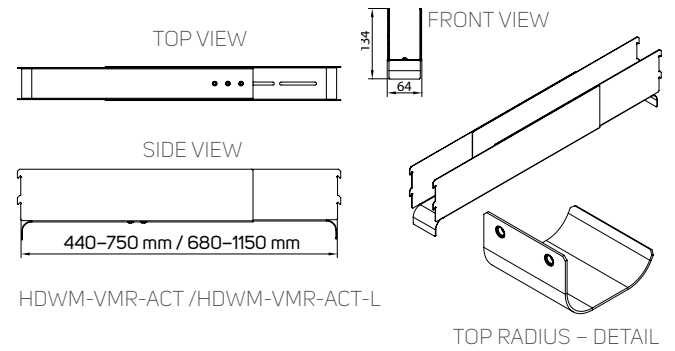

Package includes:

- HDWM-VMX-ACT-X: 1x duct, 2x radius control, 4x screws M5

### ACCESSORIES FOR HIGH DENSITY WIRE MANAGERS

Code	Description	Package
HDWM-VMR-19	Bracket for attachment of HDWM-VMR-XX-XX/XXF to 19" profiles (not required for RDF/RSF)	1 set
HDWM-VMR-ACT	Adjustable cable trough - for front-to-rear cable management between front and rear mounted VMR, top radius included, range 440 to 750 mm*	1 set
HDWM-VMF-ACT	Adjustable cable trough - for front-to-rear cable management between front and rear mounted VMF, top radius included, range 440 to 750 mm	1 set
HDWM-VMR-ACT-L	Adjustable cable trough - Long - for front-to-rear cable management between front and rear mounted VMR, top radius included, range 680 to 1150 mm*	1 set
HDWM-VMF-ACT-L	Adjustable cable trough - Long - for front-to-rear cable management between front and rear mounted VMF, top radius included, range 680 to 1150 mm	1 set
HDWM-VMF-B15	Bracket for attachment of HDWM-VMF-XX-15/XXF to back of open frame (not required for RSG)	2 pcs
HDWM-VMF-B25	Bracket for attachment of HDWM-VMF-XX-25/XXFR to back of open frame (not required for RSG)	2 pcs
HDWM-VMF-BLANK-42	Blank panel kit to close ACT holes for 42U VMF range of wire managers	3 pcs
HDWM-VMF-BLANK-45	Blank panel kit to close ACT holes for 45/47U VMF range of wire managers	3 pcs
HDWM-FSS-50	Fiber storage spools, 50 mm deep, including mounting hardware	1 pair
HDWM-FSS-100	Fiber storage spools, 100 mm deep, including mounting hardware	1 pair
HDWM-VCT-B	Velcro cable belt, 13x5000 mm, black	1 pc
HDWM-VCT-S	Velcro cable ties-small, 13x190 mm, black	25 pcs
HDWM-VCT	Velcro cable ties, 25x300 mm, black	10 pcs

\* Not compatible with divided rear extrusions of RSF rack (option U)



HDWM-FSS-50



HDWM-VCT-S



HDWM-VCT-B



HDWM-VCT

### DIFFERENCES BETWEEN LONGER AND STANDARD VERSION

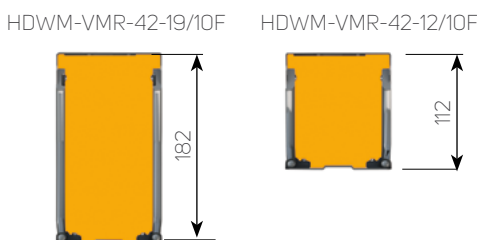

Note: All dimensions in mm

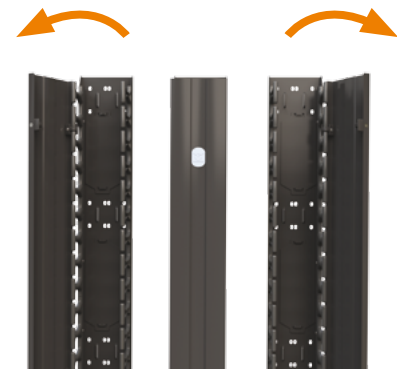

OPENING SYSTEM RIGHT AND LEFT SIDE

# OPTIWAY OPTICAL PATHWAY SYSTEM



➤ **OptiWay** is designed to provide a safe, easy-to-use and cost-effective management system for fragile optical cables. OptiWay allows you to route fiber-optic cables between equipment, providing both the physical protection and bend radius management crucial to optical cable performance.

## MAIN ADVANTAGES

- Designed to make optical cable management systems safe and easy-to-use
- Fully modular, scalable system
- Bend radius protection
- Halogen-free PC-ABS material, compliant with UL 94 V-0
- Designed for three installation variables: hung from ceiling, top of rack support or a combination of these
- Multilevel installation
- The final design can be fully customizable

Description of pictures 1 and 2 below		
No.	Code	Description
1	OPW-10DR	Spillover
2	OPW-10IA90	Vertical inside elbow
3	OPW-16MD2M	Main duct
4	OPW-10JO	Joiner
5	OPW-10TP	Trumpet
6	OPW-RRB-100	Threaded rod attachment bracket (rack mounting)
7	OPW-TR-16/20	Threaded rod
8	OPW-TR-BR	Threaded rod mounting bracket
9	OPW-TR-16/100	Threaded rod
10	OPW-30MD2M	Main duct
11	OPW-TRB-30	Threaded rod attachment bracket (ceiling mounting)

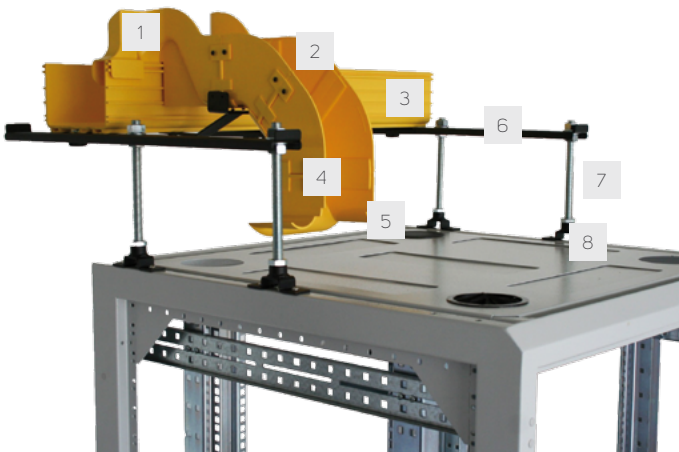

1. OptiWay installation on top of rack

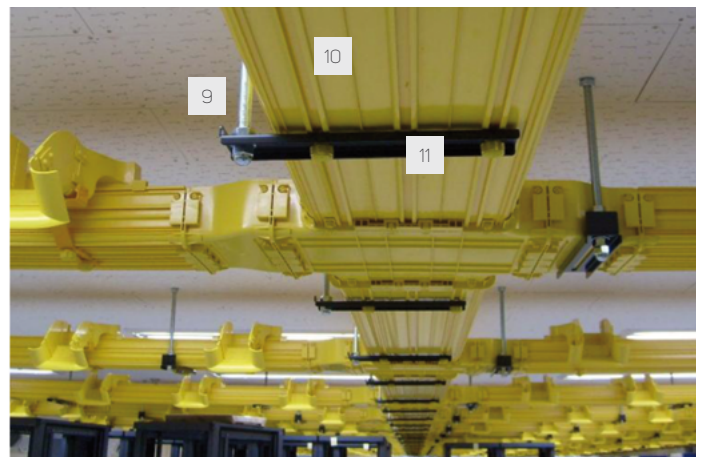

2. OptiWay ceiling installation

## MAIN DUCT



OPW-16MD2M-YL

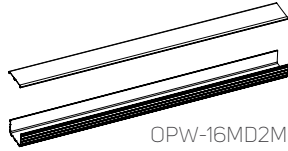
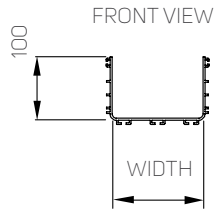

OPW-16MD2MC-YL

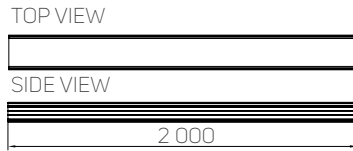

- An extruded 2-meter-long conduit; can be connected with other OptiWay products using joiners
- Delivered in even numbers (packaged by 2 pcs = 4 m)
- Can be easily cut to length on-site
- Duct load rating 20 kg/m; required distance between brackets max. 900 mm
- Color: Yellow

Code	Inner duct size (mm)		Length (m)	Package
	H	W		
OPW-16MD2M-YL	100	160	2	2 pcs
OPW-30MD2M-YL	100	300	2	2 pcs
<b>COVERS</b>				
OPW-16MDC2M-YL	-	160	2	1 pc
OPW-30MDC2M-YL	-	300	2	1 pc

## JOINER

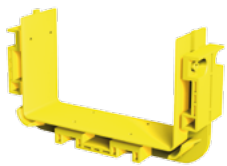

OPW-16JO-YL

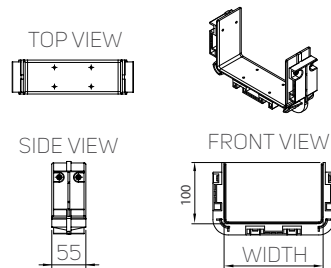

- Used to connect two OptiWay component
- Does not require drilling of duct or components
- Color: Yellow
- Package includes: 1x joiner, 8x screws

Code	Inner duct size (mm)		Package
	H	W	
OPW-10JO-YL	100	100	1 pc
OPW-16JO-YL	100	160	1 pc
OPW-30JO-YL	100	300	1 pc

## CROSS



OPW-16CA-YL



OPW-16CAC-YL

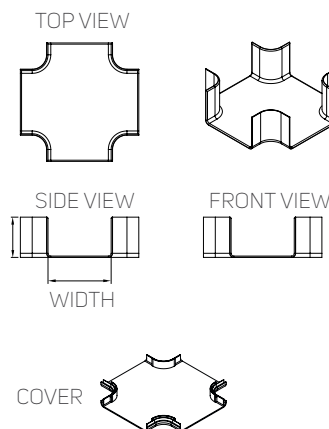

- Used to establish a 4-way, right-angled intersection
- Four joiners required per cross
- Color: Yellow

Code	Inner duct size (mm)		Package
	H	W	
OPW-16CA-YL	100	160	1 pc
OPW-30CA-YL	100	300	1 pc
<b>COVERS</b>			
OPW-16CAC-YL	-	160	1 pc
OPW-30CAC-YL	-	300	1 pc

Note: All dimensions in mm

## REDUCER

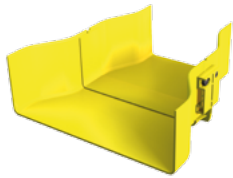

OPW-3016RD-YL

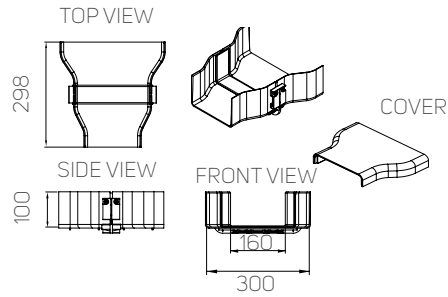

- Allows 300×100 mm and 160×100 mm OptiWay sections to be joined together
- Two joiners required per reducer
- Color: Yellow

Code	Inner duct size (mm)		Package
	H	W1 / W2	
OPW-3016RD-YL	100	300 / 160	1 pc
<b>COVERS</b>			
OPW-3016RDC-YL	-	300 / 160	1 pc

## TEE



OPW-16TA-YL

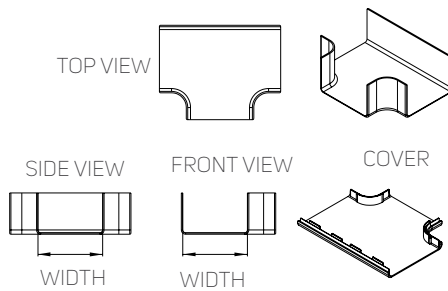

- Used to establish a 3-way, right-angled intersection
- Three joiners required per tee
- Color: Yellow

Code	Inner duct size (mm)		Package
	H	W	
OPW-16TA-YL	100	160	1 pc
OPW-30TA-YL	100	300	1 pc
<b>COVERS</b>			
OPW-16TAC-YL	-	160	1 pc
OPW-30TAC-YL	-	300	1 pc

## HORIZONTAL ELBOW

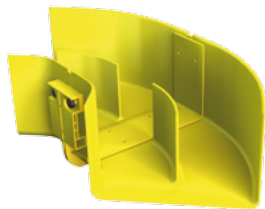

OPW-16HA90-YL

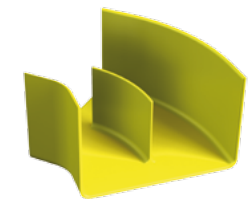

OPW-16HA45-YL



OPW-16HA90C-YL

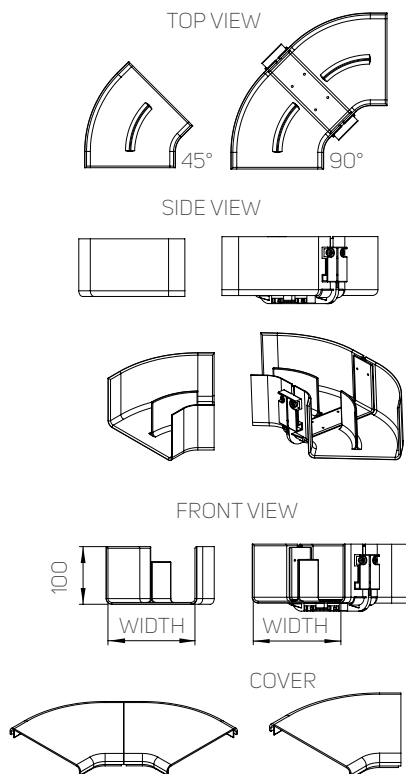

- Allows ducts to be diverted through 45° or 90°
- Two joiners required per elbow
- Color: Yellow

Code	Type	Inner duct size (mm)		Package
		H	W	
OPW-16HA45-YL	45°	100	160	1 pc
OPW-30HA45-YL	45°	100	300	1 pc
OPW-16HA90-YL	90°	100	160	1 pc
OPW-30HA90-YL	90°	100	300	1 pc
<b>COVERS</b>				
OPW-16HA45C-YL	45°	-	160	1 pc
OPW-30HA45C-YL	45°	-	300	1 pc
OPW-16HA90C-YL	90°	-	160	1 pc
OPW-30HA90C-YL	90°	-	300	1 pc

Note: All dimensions in mm

## VERTICAL INSIDE ELBOW

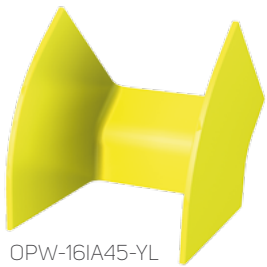

OPW-16IA45-YL

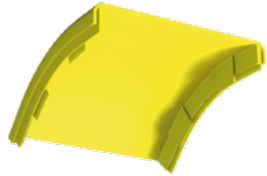

OPW-16IA45C-YL

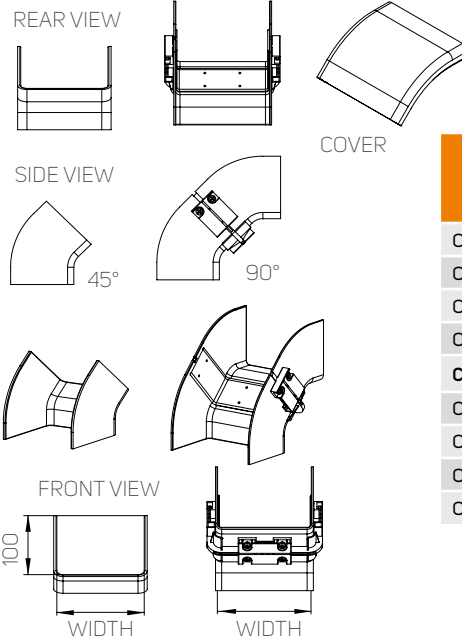

- Allows ducts to be diverted through 45° or 90° with an inside angle (usually in a downward direction)
- Two joiners required per elbow
- Color: Yellow

Code	Type	Inner duct size (mm)		Package
		H	W	
OPW-16IA45-YL	45°	100	160	1 pc
OPW-30IA45-YL	45°	100	300	1 pc
OPW-16IA90-YL	90°	100	160	1 pc
OPW-30IA90-YL	90°	100	300	1 pc
<b>COVERS</b>				
OPW-16IA45C-YL	45°	-	160	1 pc
OPW-30IA45C-YL	45°	-	300	1 pc
OPW-16IA90C-YL	90°	-	160	1 pc
OPW-30IA90C-YL	90°	-	300	1 pc

## SPILOVER



OPW-10DR-YL



OPW-10DRC-YL



OPW-10DRF-YL



OPW-10DRFC-YL



OPW-10DRF-TG + OPW-10DRF-TB3

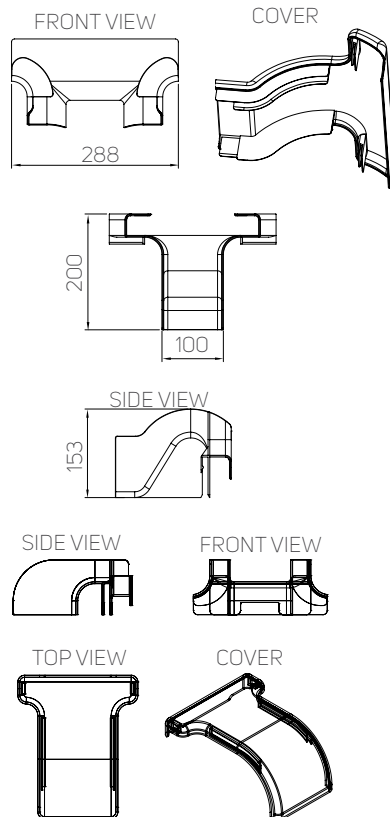

Code	Inner duct size (mm)		Package
	H	W	
OPW-10DR-YL	100	100	1 pc
OPW-10DRF-YL	100	100	1 pc
<b>COVERS</b>			
OPW-10DRC-YL	-	100	1 pc
OPW-10DRFC-YL	-	100	1 pc

SPILOVER ACCESSORIES		
Code	Description	Package
OPW-10JO-YL	OptiWay 100 Joiner, 100x100 mm, yellow	1 pc
OPW-10TP-YL	OptiWay 100 Trumpet, 100x100 mm, yellow	1 pc
OPW-10IA45-YL	OptiWay 100 mm, 45° down angle, yellow	1 pc
OPW-SDMB-16	OptiWay Side Drop Mounting Bracket for 160x100 mm duct	1 pc
OPW-SDMB-30	OptiWay Side Drop Mounting Bracket for 300x100 mm duct	1 pc
OPW-10DRF-TG	OptiWay 100 Spillover fall-out tube guide (up to two tubes), without tube, black	1 pc
OPW-10DRF-TB3	OptiWay 100 tube for spillover, outer diam. 40 mm, length 3 m, black	1 pc
OPW-10DRF-TB30	OptiWay 100 tube for spillover, outer diam. 40 mm, length 30 m, black	1 pc

- Used to provide a protected exit for cables leaving the OptiWay ducting system
- Color: Yellow

## VERTICAL OUTSIDE ELBOW

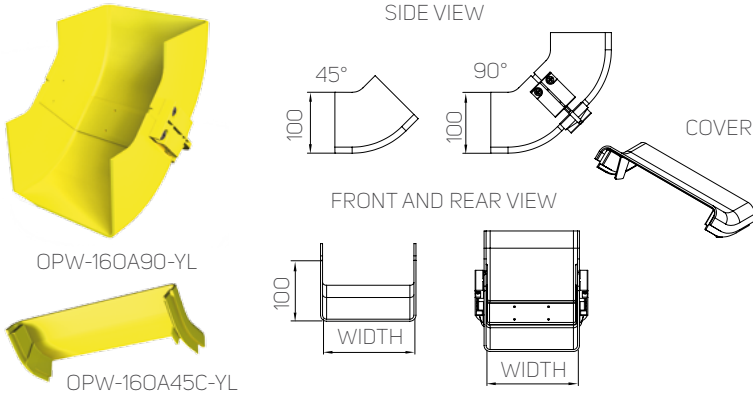

OPW-160A90-YL

OPW-160A45C-YL

- Allows ducts to be diverted through 45° or 90° with an inside angle (usually in an upward direction)
- Two joiners required per elbow
- Color: Yellow

Code	Angle	Inner duct size (mm)		Package
		H	W	
OPW-160A45-YL	45°	100	160	1 pc
OPW-300A45-YL	45°	100	300	1 pc
OPW-160A90-YL	90°	100	160	1 pc
OPW-300A90-YL	90°	100	300	1 pc
<b>COVERS</b>				
OPW-160A45C-YL	45°	-	160	1 pc
OPW-300A45C-YL	45°	-	300	1 pc
OPW-160A90C-YL	90°	-	160	1 pc
OPW-300A90C-YL	90°	-	300	1 pc

## TRUMPET

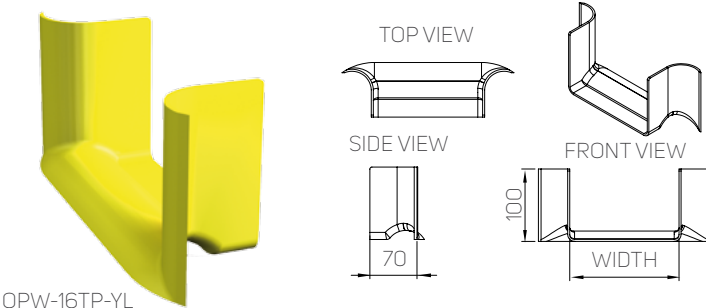

OPW-16TP-YL

- Used to provide bend-radius control for cables entering or exiting the OptiWay ducting system
- One joiner required per trumpet
- Color: Yellow

Code	Inner duct size (mm)		Package
	H	W	
OPW-10TP-YL	100	100	1 pc
OPW-16TP-YL	100	160	1 pc
OPW-30TP-YL	100	300	1 pc

## END CAP

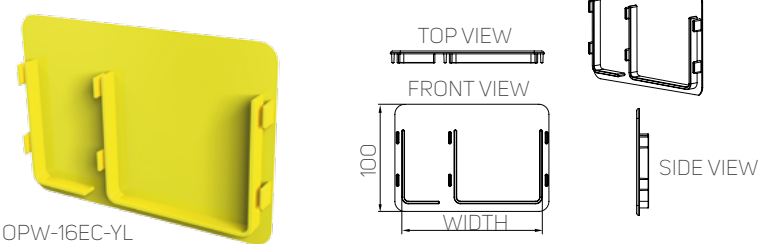

OPW-16EC-YL

- Provides a clean finish to end of OptiWay run
- Color: Yellow

Code	Inner duct size (mm)		Package
	H	W	
OPW-16EC-YL	100	160	1 pc
OPW-30EC-YL	100	300	1 pc

## SPILLOVER SUPPORT BRACKET

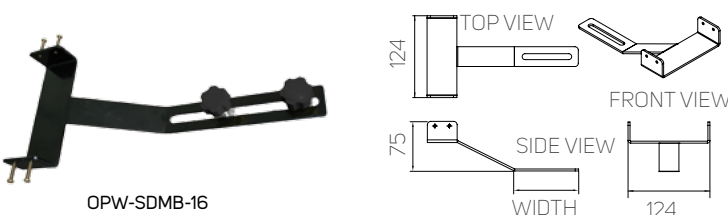

OPW-SDMB-16

- Spillover OPW-10DR-YL supporting element
- Color: Black
- Package includes: metal bracket and 2× fixing screws

Code	Supported duct inner size (mm)		Package
	H	W	
OPW-SDMB-16	100	160	1 pc
OPW-SDMB-30	100	300	1 pc

Note: All dimensions in mm



# THREADED ROD ATTACHMENT BRACKET



OPW-TRB

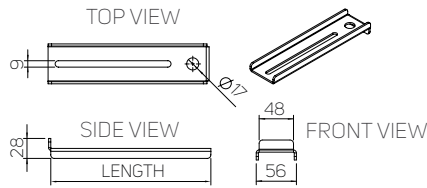

FRONT VIEW



- Basic supporting element
- Color: Black
- Recommended 12–16 mm diameter threaded rod
- Package includes: metal bracket and 2× fixing screws
- Please note: brackets do not include threaded rod

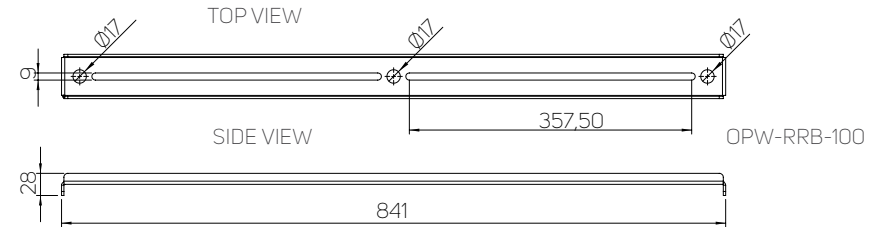

OPW-RRB-100

Code	Bracket length (mm)	Mounting type	Rec. rack depth (mm)	Mount. holes	Package
OPW-TRB-16	160	Ceiling-mounted	all	1	1 pc
OPW-TRB-30	300	Ceiling-mounted	all	1	1 pc
OPW-RRB-40	344	Mounted on top of the half part of the rack	800	2	1 pc
OPW-RRB-50	444	Mounted on top of the half part of the rack	1000	2	1 pc
OPW-RRB-60	644	Mounted on top of the half part of the rack	1200	2	1 pc
OPW-RRB-80	641	On top of or overlapping the rack	800	3	1 pc
OPW-RRB-100	841	On top of or overlapping the rack	1000	3	1 pc
OPW-RRB-120	1041	On top of or overlapping the rack	1200	3	1 pc
OPW-SRB-60	632	OptiWay – side mounting bracket for installation of cable duct on a 600 mm wide rack – front/rear orientation	–	2	1 pc
OPW-SRB-80	832	OptiWay – side mounting bracket for installation of cable duct on a 800 mm wide rack – front/rear orientation	–	2	1 pc

Note: Max. distance required between RRB brackets: 900 mm

# THREADED ROD MOUNTING BRACKETS

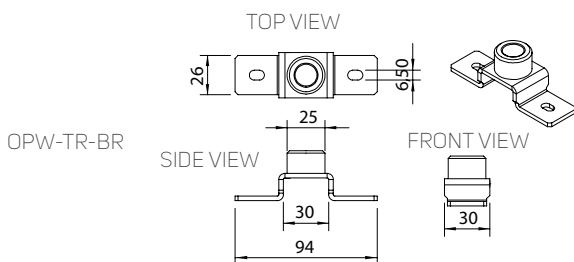

OPW-TR-BR

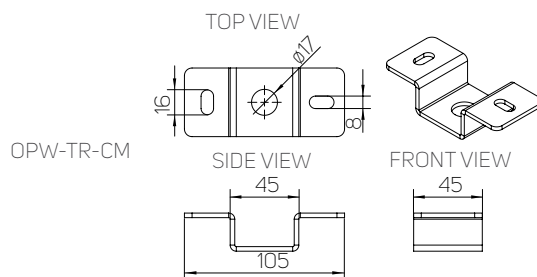

OPW-TR-CM

Code	Supported duct inner size (mm)		Mounting type	Package
	H	Size		
OPW-TR-16/100	1000	M16	From the ceiling	1 pc
OPW-TR-16/200	2000	M16	From the ceiling	1 pc
OPW-TR-16/20	210	M16	On top of the rack using OPW-TR-BR	1 pc
OPW-TR-16/40	400	M16	On top of the rack using OPW-TR-BR	1 pc
OPW-TR-16/60	600	M16	On top of the rack using OPW-TR-BR	1 pc
OPW-TR-BR	–	M16	Threaded rod mounting bracket for top part of RDF/RSF	1 pc
OPW-TR-CM	–	M16	Threaded rod mounting bracket for ceiling installation with OPW-TR-16/100 or 200	1 pc

# CABLE MANAGEMENT

## TOP DUCT

➤ **Top ducts** are designed to provide a safe, cost-effective and easy-to-use management system for copper cables above the racks. Top ducts are simple to install and allow for easy installation, manipulation and re-patching of copper cables between server, network and UPS racks. The system is designed to provide a simple connection between the rack rows without ceiling or other exterior support, reducing installation time and allowing for ease of changeability. The connection between rack rows can be multi-layered, and can be combined with the Conteg OptiWay pathway system to provide independent routes for fiber cables. This solution complies with market requirements, recommendations and best practices.

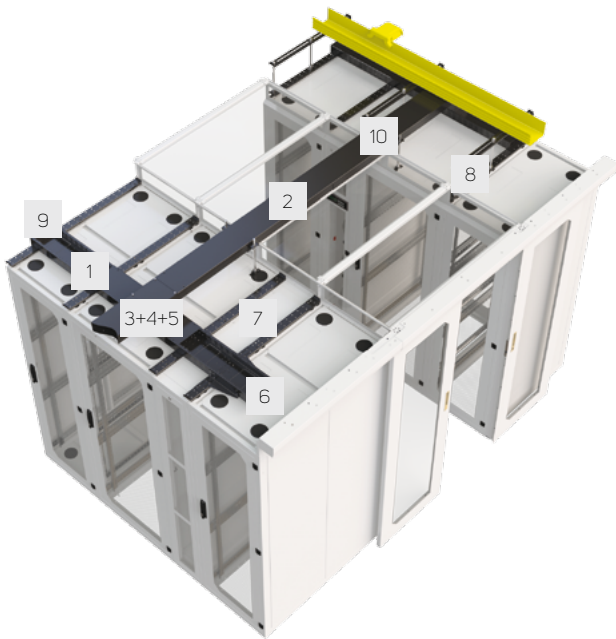

### MAIN ADVANTAGES

- Designed for copper cables above racks
- Simple connection between racks and rows of racks
- Compatible and combinable with OPTIWAY
- Backbone cable management system above racks
- Length corresponding to rack width
- Easy installation, maximal tool-less support
- Adjustable cross-connection ducts above corridors and contained aisles

### MAIN COMPONENTS

- Top duct
- Cross connection
- Radius protectors and accessories
- Supporting brackets for use with Conteg OptiWay pathway system
- Supporting brackets for use without Conteg OptiWay pathway system
- Accessories for cable management

COLOR SAMPLER:  RAL 9005



Code	Dimensions (mm)			Package
	H	W	L	
<b>MAIN DUCT</b>				
CPW-20TD30	70	200	300	2 pcs
CPW-20TD40	70	200	400	2 pcs
CPW-20TD60	70	200	600	2 pcs
CPW-20TD80	70	200	800	2 pcs
CPW-20TD35	70	200	350	1 pc
<b>COVERS</b>				
CPW-20TDC10	-	200	100	2 pcs
CPW-20TDC20	-	200	200	2 pcs
CPW-20TDC30	-	200	300	2 pcs
CPW-20TDC40	-	200	400	2 pcs
CPW-20TDC50	-	200	500	2 pcs
CPW-20TDC60	-	200	600	2 pcs
CPW-20TDC80	-	200	800	2 pcs
CPW-20TDC35	-	200	350	1 pc

## TOP DUCTS – CROSS CONNECTION



- Allows a cable management system to be installed across one or more rows of racks
- Includes several adjustable features, allowing the required duct length on a multilevel basis
- Can be covered with tool-less covers

Code	Dimensions (mm)			Package
	H	W	L	
<b>CROSS CONNECTION</b>				
CPW-20CD100	70	200	1034-1480	1 pc
CPW-20CD140	70	200	1434-2280	1 pc
CPW-20CD180	70	200	1834-3080	1 pc
CPW-20CD220	70	200	2234-3880	1 pc
CPW-20CD260	70	200	2634-4680	1 pc
<b>COVERS</b>				
CPW-20CDC100	–	200	1034-1480	2 pcs
CPW-20CDC140	–	200	1434-2280	2 pcs
CPW-20CDC180	–	200	1834-3080	2 pcs
CPW-20CDC220	–	200	2234-3880	2 pcs
CPW-20CDC260	–	200	2634-4680	2 pcs

## TOP DUCT – ACCESSORIES

- Used for multilevel cross connection
- Can be used with/without contained aisle solutions for racks 42U, 45U or 48U in height



Code	Description	Package
<b>CROSS AND TEE MEMBERS – FOR MULTILEVEL INTERSECTION</b>		
CPW-20CA	Cross member between CPW-20TDXX and 2x CPW-20CDXX (for CPW-20CDXX when used crosswise)	1 pc
CPW-20CC-SM	Set of 2 support brackets for CPW-20CDXX; only for CCA with 42U racks or for crossover	1 pair
CPW-20CAC-OU	Cover for cross member CPW-20CA	1 pc
CPW-20CAC-3U	Cover for cross member CPW-20CA, offset use	1 pc
CPW-20TAC-OU	Cover of tee connection from CPW-20CDXX to CPW-20TDXX when 45U and 48U racks are used	1 pc
CPW-20TAC-3U	Cover of tee connection from CPW-20CDXX to CPW-20TDXX when CCA or CPW-20CC-SM are used; only for 42U racks	1 pc
<b>CABLE DUCT ACCESSORIES</b>		
CPW-20-R17	Radius cable protection for CPW-20TDXX, 170 mm width; 2 pieces with plastic pins	2 pcs
CPW-20-R10	Radius cable protection for CPW-20TDXX, 100 mm width; 2 pieces with plastic pins	2 pcs
CPW-20-R20	Radius cable protection for end of CPW-20TDXX or CPW-20CDXX, 200 mm width; 2 pieces with plastic pins	2 pcs
CPW-20-EC	End cap of CPW-20TDXX	2 pcs
CPW-20-CC	Connecting kit for CPW-20TDXX for direct application on rack roof, unnecessary when using CPW-RRB-XX	10 pcs
<b>CABLE MANAGEMENT</b>		
DP-KP-LEM	Protective ending of cable entries for free standing racks (length 790 mm)	1 pc
HDWM-VCT	Velcro cable ties, 25×300 mm, black	10 pcs
HDWM-VCT-B	Velcro cable belt, 13×5000 mm, black	1 pc
HDWM-VCT-S	Velcro cable ties-small, 13×190 mm, black	25 pcs

# SUPPORTING BRACKETS



- Ducts can be installed directly onto the roof of the rack with or without the OptiWay pathway system
- Supporting brackets intended for use without OptiWay can be easily installed and adjusted above the racks
- Supporting brackets intended for use with OptiWay
- Combines both OptiWay and Top duct systems
- Equipped with holes for threaded rods, used to support the OptiWay system at different levels

Code	Bracket length (mm)	Mounting type	Recommended rack depth (mm)	Mounting holes	Package
<b>SUPPORTING BRACKETS WITHOUT OPTIWAY</b>					
CPW-BR-BR	-	Top duct bracket for installation of CPW-RRB on racks RSF/RDF	-	-	1 pc
CPW-RRB-40	340	Top duct half-size mounting bracket for installation of cable duct CPW-20TDXX on roof of rack, 80 cm depth	800	2	1 pc
CPW-RRB-50	440	Top duct half-size mounting bracket for installation of cable duct CPW-20TDXX on roof of rack, 100 cm depth	1000	2	1 pc
CPW-RRB-60	540	Top duct half-size mounting bracket for installation of cable duct CPW-20TDXX on roof of rack, 120 cm depth	1200	2	1 pc
CPW-RRB-80	740	Top duct full-size mounting bracket for installation of cable duct CPW-20TDXX on roof of rack, 80 cm depth	800	3	1 pc
CPW-RRB-100	940	Top duct full-size mounting bracket for installation of cable duct CPW-20TDXX on roof of rack, 100 cm depth	1000	3	1 pc
CPW-RRB-120	1140	Top duct full-size mounting bracket for installation of cable duct CPW-20TDXX on roof of rack, 120 cm depth	1200	3	1 pc

Code	Bracket length (mm)	Mounting type	Recommended rack depth (mm)	Mounting holes	Package
<b>SUPPORTING BRACKETS WITH OPTIWAY</b>					
OPW-TR-BR	-	Bracket for installing threaded rod on racks RSF/RDF	-	-	1 pc
OPW-TR-16/20	210	Rack mounting threaded rod for OptiWay, M16, 21 cm length	-	-	1 pc
OPW-TR-16/40	400	Rack mounting threaded rod for OptiWay, M16, 40 cm length	-	-	1 pc
OPW-TR-16/60	600	Rack mounting threaded rod for OptiWay, M16, 60 cm length	-	-	1 pc
OPW-TR-16/100	1000	Threaded rod for OptiWay, M16, 100 cm length	-	-	1 pc
OPW-TR-16/200	2000	Threaded rod for OptiWay, M16, 200 cm length	-	-	1 pc
OPW-TR-CM	-	OptiWay ceiling-mounting holder for threaded rod	-	-	1 pc
CPW-ORB-40	380	Top duct half-size mounting bracket for installation of cable duct CPW-20TDXX on rack roof, depth 80 cm; used with Optiway (OPW-TR-BR and OPW-TR-16/XX needed)	800	2	1 pc
CPW-ORB-50	480	Top duct half-size mounting bracket for installing cable duct CPW-20TDXX on rack roof, 100 cm depth; used with OptiWay (OPW-TR-BR and OPW-TR-16/XX needed)	1000	2	1 pc
CPW-ORB-60	580	Top duct half-size mounting bracket for installing cable duct CPW-20TDXX on rack roof, 120 cm depth; used with OptiWay (OPW-TR-BR and OPW-TR-16/XX needed)	1200	2	1 pc
CPW-ORB-80	880	Top duct full-size mounting bracket for installing cable duct CPW-20TDXX on rack roof, 80 cm depth; used with OptiWay (OPW-TR-BR and OPW-TR-16/XX needed)	800	3	1 pc
CPW-ORB-100	880	Top duct full-size mounting bracket for installing cable duct CPW-20TDXX on rack roof, 100 cm depth; used with OptiWay (OPW-TR-BR and OPW-TR-16/XX needed)	1000	3	1 pc
CPW-ORB-120	1080	Top duct full-size mounting bracket for installing cable duct CPW-20TDXX on rack roof, 120 cm depth; used with OptiWay (OPW-TR-BR and OPW-TR-16/XX needed)	1200	3	1 pc
CPW-CDB	-	Top duct cross connection support – rack or ceiling installation (used with threaded rods and mounting brackets)	-	2	1 pc

# STANDARD CABLE MANAGEMENT

## 19" WIRE MANAGEMENT PANELS WITH PLASTIC BRACKETS

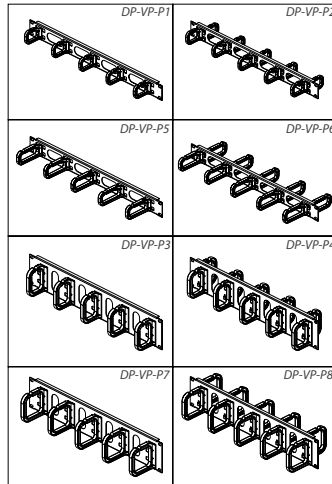
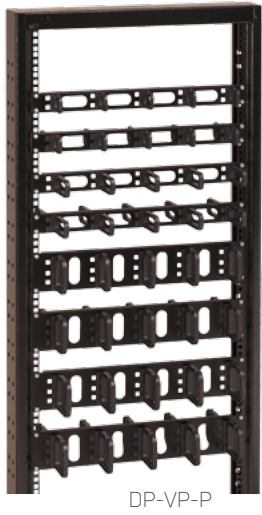

- Used for storing and managing cables horizontally within the rack
- Height: 1U or 2U
- Available in "front only" and "front and rear" variables
- 5 plastic brackets per side
- Oval openings in panel allow front to rear cabling
- Color: powder-coated RAL 9005; black brackets

Code	H (in U)	Type	Hook sizes HxD (mm)	Number of brackets	Package
DP-VP-P1	1	Front only	40x50	5	1 pc
DP-VP-P2	1	Both sides	40x50	10	1 pc
DP-VP-P3	2	Front only	80x60	5	1 pc
DP-VP-P4	2	Both sides	80x60	10	1 pc
DP-VP-P5	1	Front only	40x80	5	1 pc
DP-VP-P6	1	Both sides	40x80	10	1 pc
DP-VP-P7	2	Front only	80x80	5	1 pc
DP-VP-P8	2	Both sides	80x80	10	1 pc

## PLASTIC CABLE BRACKETS

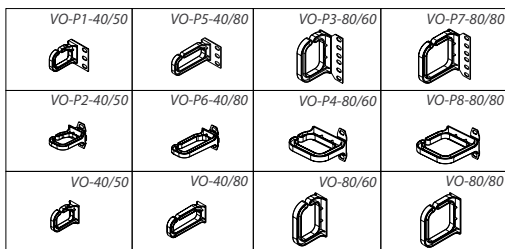

- Mounted on 19" vertical extrusions for management of horizontal and vertical cabling within the rack
- Types:
  - a) For managing vertical cables
  - b) For managing horizontal cables
- Equipped with metal flange for installing onto 19" vertical extrusions
- Color: powder-coated RAL 9005; black brackets

Code	H (mm)	D (mm)	Orientation	Package
VO-P1-40/50	40	50	Horizontal	10 pcs
VO-P2-40/50	40	50	Vertical	10 pcs
VO-P3-80/60	80	60	Horizontal	10 pcs
VO-P4-80/60	80	60	Vertical	10 pcs
VO-P5-40/80	40	80	Horizontal	10 pcs
VO-P6-40/80	40	80	Vertical	10 pcs
VO-P7-80/80	80	80	Horizontal	10 pcs
VO-P8-80/80	80	80	Vertical	10 pcs

## 19" WIRE MANAGEMENT PANELS WITH PLASTIC DUCTS

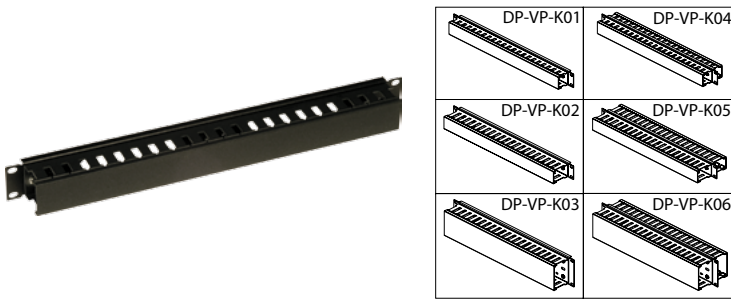

- Used for storing and managing cables horizontally within the rack
- Height: 1U or 2U
- Available in "front-only" and "front-and-rear" variables
- Plastic duct for cable managing
- Oval openings in panel allow front to rear cable passage
- Color: powder-coated RAL 9005

Code	H (in U)	Type	Duct sizes HxD (mm)	Package
DP-VP-K01	1	Front only	40x40	1 pc
DP-VP-K02	1	Front only	40x60	1 pc
DP-VP-K03	2	Front only	80x60	1 pc
DP-VP-K04	1	Both sides	40x40	1 pc
DP-VP-K05	1	Both sides	40x60	1 pc
DP-VP-K06	2	Both sides	80x60	1 pc

## WIRE MANAGEMENT PANELS WITH METAL BRACKETS

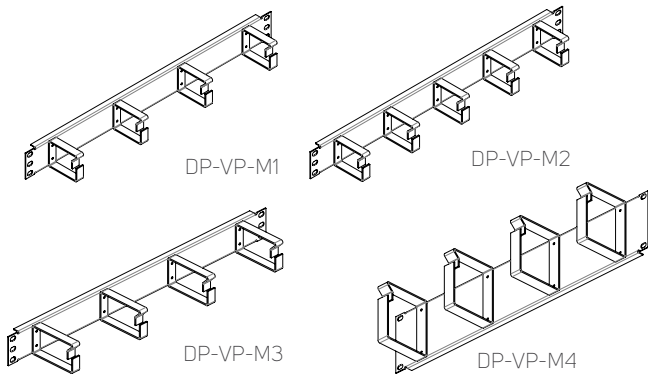

- Used for storing and managing cables horizontally within the rack
- Height: 1U or 2U
- Available in "front only"
- 4 or 5 metal brackets per side
- Full panel without openings
- Color: powder-coated RAL 9005

Code	H (in U)	Hook sizes HxD (mm)	Number of brackets	Package
DP-VP-M1	1	44x55	4	1 pc
DP-VP-M2	1	44x55	5	1 pc
DP-VP-M3	1	44x76	4	1 pc
DP-VP-M4	2	88x76	4	1 pc

## METAL CABLE BRACKETS

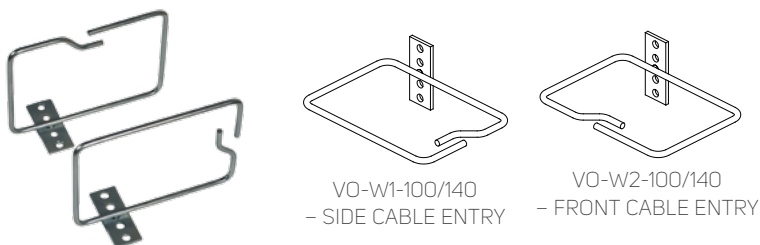

- Mounted on 19" vertical extrusions; used for vertical cable management in racks
- One-chamber dimensions 100x100 or 100x140 mm with front or side cable entry
- Two-chamber dimensions 230x100 or 300x100 mm with side cable entry
- Flange with 4 holes for installation on front or side of 19" vertical extrusion
- Zinc-plated

Code	Dimensions (mm)		Cable entry	Package
	W	D		
VO-W1-100/140	140	100	side	10 pcs
VO-W2-100/140	140	100	front	10 pcs
VO-W2-100/100	100	100	front	10 pcs
VO-W3-100/230	230	100	2x side	10 pcs
VO-W3-100/300	300	100	2x side	10 pcs



## VERTICAL WIRE MANAGEMENT PANELS AND CABLE BRACKET HOLDERS



HVMP - 42



HVMF 42U

- Used for installation of vertical wire management panels, cable brackets (ordered separately) or additional 19" space in 800 mm wide free-standing racks
- Two designs: HVMF and HVMP
- HVMF – ready for cable management; compatible with VO-XX/YY and DP-VP-VR-XX
- HVMP – additional 3×1U 19" space (load rating 5 kg per position); compatible with separation frame
- Color: powder-coated RAL 9005

Code	Rack height (in U)	Package
HVMF-15	15	1 pair
HVMF-21	21	1 pair
HVMF-27	27	1 pair
HVMF-33	33	1 pair
HVMF-42	42	1 pair
HVMF-45	45	1 pair
HVMF-48	48	1 pair
HVMP-42	42	1 pair
HVMP-45	45	1 pair
HVMP-48	48	1 pair

## VERTICAL WIRE MANAGEMENT PANELS



DP-VP-VR-42U

- Used for storing and managing cables vertically in 800 mm wide free-standing racks
- For racks 15–48U high
- 80×60 mm plastic duct for cable management
- Oval openings in base of ducts allow front to rear cabling
- Ducts with a minimum height of 33U have divided covers for easier handling
- Installed onto front of vertical extrusions using vertical wire holder; management panels (HVMF) – ordered separately
- Color: powder-coated RAL 9005

Code	Rack height (in U)	Package
DP-VP-VR-15	15	1 pc
DP-VP-VR-21	21	1 pc
DP-VP-VR-27	27	1 pc
DP-VP-VR-33	33	1 pc
DP-VP-VR-42	42	1 pc
DP-VP-VR-45	45, 48	1 pc

## HORIZONTAL CABLE TRAY AND SIDE CABLE MANAGEMENT HOLDERS

HVMS-H-600

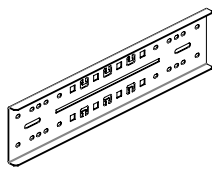

HVMS-H-800

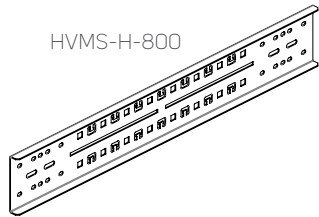

HVMS-H-A

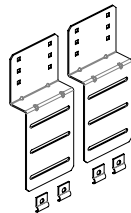

- HVMS-H-A: holder for HVMS-B, DP-UL at RSF or iSEVEN SERVER series with A-type extrusions, mounted on horizontal holders
- HVMS-H: for all rack series (recommended for RM7 and RI7), mounted on vertical extrusions
- Mounting kit included

Code	Used in rack sizes (mm)		Package
	RSF with A extrusions/RDF	iSEVEN family	
HVMS-H-A	All dimensions	–	1 pair
HVMS-H-600	–	600×600, 800×600	1 pair
HVMS-H-800	800×800	600×800, 800×800	1 pair

## SIDE CABLE PERFORATED PANELS FOR A-TYPE EXTRUSIONS



DP-VV-A-42

- Used for storing and managing cables horizontally within the rack
- Used in free-standing racks 42–48U in high
- Available width – 100 mm
- Installation directly in top and bottom frame of the PREMIUM rack or iSEVEN SERVER (with A type extrusions only)
- Installation kit is included in delivery

Code	Used in rack height (U)	Package
DP-VV-A-42	42	1 pc
DP-VV-A-45	45	1 pc
DP-VV-A-48	48	1 pc

## CABLE BASKET TRAYS

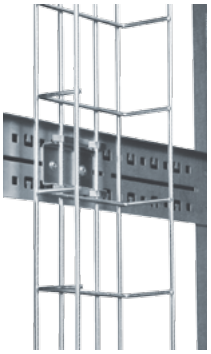

HVMS-B

- Cable basket trays HVMS-B are used to guide and support vertical cables in free-standing racks between 19" extrusions and side panels
- 140×30 mm (W×D); can be mounted between horizontal holder and side panel
- 300×60 mm and 400×60 mm (W×D); mounted on inner side of horizontal holder
- 140×60 mm (W×D); mounted on inner side of horizontal holder
- Produced for rack sizes 15–48U
- Mounted on holders of vertical extrusions – RDF/RI7/RM7 and RSF with T or U extrusion option; at RSF and iSEVEN SERVER with A-type extrusions, use with HVMS-H-A
- Set of fittings (included)
- Package includes:
  - Set 1: 1× cable basket, 2× holders
  - Set 2: 1× cable basket, 4× holders

Code	Dimensions (mm)			Used in rack height (U)	Package
	H	W	D		
HVMS-B-600-140/30	605	170	35	15	1 pc of set 1
HVMS-B-800-140/30	805	170	35	21	1 pc of set 1
HVMS-B-1000-140/30	1005	170	35	27	1 pc of set 1
HVMS-B-1400-140/30	1405	170	35	33	1 pc of set 1
HVMS-B-1800-140/30	1805	170	35	42, 45, 48	1 pc of set 1
HVMS-B-600-140/60	605	170	65	15	1 pc of set 1
HVMS-B-800-140/60	805	170	65	21	1 pc of set 1
HVMS-B-1000-140/60	1005	170	65	27	1 pc of set 1
HVMS-B-1400-140/60	1405	170	65	33	1 pc of set 1
HVMS-B-1800-140/60	1805	170	65	42, 45, 48	1 pc of set 1
HVMS-B-1800-300/60	1805	325	65	42, 45, 48	1 pc of set 2
HVMS-B-1800-400/60	1805	425	65	42, 45, 48	1 pc of set 2

## SIDE CABLE PERFORATED PANELS



DP-VV-42U/300

- Panels DP-VV are used to guide and support vertical cables in free-standing racks between 19" extrusions and side panels
- Used in free-standing racks 15–48U in height
- Available widths – 150 mm and 300 mm
- Installation either directly in top and bottom frame of the rack (OPTIMAL/PREMIUM racks series only) or on vertical extrusion holders (all free-standing rack series)
- Installation kit included in delivery

Code		Used in rack height (U)	Package
Panel width 150 mm	Panel width 300 mm		
DP-VV-15U/150	DP-VV-15U/300	15	1 pc
DP-VV-21U/150	DP-VV-21U/300	21	1 pc
DP-VV-27U/150	DP-VV-27U/300	27	1 pc
DP-VV-33U/150	DP-VV-33U/300	33	1 pc
DP-VV-42U/150	DP-VV-42U/300	42	1 pc
DP-VV-45U/150	DP-VV-45U/300	45	1 pc
DP-VV-48U/150	DP-VV-48U/300	48	1 pc

## SIDE CABLE GRIDS



HVMS-CH

- Used for managing cables in the sides of rack behind the 19" extrusions
- Installation possible in racks 600, 800 and 1000 mm deep
- Installation kit included in delivery
- Cable ties not included in delivery
- Package includes: 1× cable grid, 4× holder

Code	Dimensions (mm)	Used in rack depths (mm)	Package
HVMS-CH-400	404×181	600, 800, 1000	1 pc
HVMS-CH-500	504×181	600, 800, 1000	1 pc
HVMS-CH-600	604×181	800, 1000	1 pc
HVMS-CH-700	704×181	800, 1000	1 pc
HVMS-CH-800	804×181	1000	1 pc



# 04

## TARGETED COOLING & AIRFLOW MANAGEMENT



<b>CoolTeg Plus Cooling Units</b>	81
CoolTeg Plus CW	82
CoolTeg Plus DX	83
CoolTeg Plus XC	85
<b>CoolTop Cooling Units</b>	87
<b>Ventilation Units</b>	88
Fans	89
Lite Ventilation Unit	89
<b>Airflow Management Products</b>	90
Contained Aisle	90
19" Blank and Fast Blank Panels	90
Air Separation Frame	91
Airflow Deflector	91
Chimney	91
19" Vented Panel	92
19" Vented Panel with Brush	92
<b>Side-To-Side Airflow Solution (STS)</b>	93



## COMPARISON OF DIFFERENT DC COOLING PRINCIPLES

	CRAC	In-row	CoolTop
Air delivery	To the whole room	Only where needed	Only where needed
Different power and temperature zones in one room	Impossible	Simple	Simple
Future system expansion	Very difficult	Easy	Easy
Redundancy cost	Very high	Low	Low; in-row combo possible
Occupied floor area	Large	Small	None
Contained Hot Aisle arrangement	Difficult	Easy	Possible
Contained Cold Aisle arrangement	Easy	Easy	Easy
Modular Closed Loop system	Impossible	Easy	Impossible

## COMPARISON OF COOLTEG PLUS CW AND COOLTOP CW

	CoolTeg Plus	CoolTop
	See page 81	See page 87
Installation	Between IT racks	On top of IT racks
Coolant	Water/antifreeze mixture of glycol	Water/antifreeze mixture of glycol
Piping system	Same	Same
Application	For all sizes	Min. 4 IT racks.
Occupied floor area (in DC)	Minimum 0,3 m <sup>2</sup> per unit	Zero
Cooling capacity per unit (kW)*	24 (CW30)/50 (CW60)	36 (CT2)/47 (CT3)
Coefficient of Performance (kW/kW)**	29.7/17.1	51.1/42.3
Requirements for chiller (chilled water production)	Same	Same

\* Nominal capacity at these conditions: air temperature in hot zone 35 °C, water temperature 10/15 °C, without condensation

\*\* At the same conditions, with maximal airflow and nominal water flow, fully open valve

## COMPARISON OF DIFFERENT COOLTEG PLUS TYPES

	CW	DX	XC
	See page 82	See page 83	See page 85
System	CoolTeg CW indoor units + water piping system + battery of chillers (variable number of units in each system)	CoolTeg DX indoor unit + refrigerant piping system + outdoor compressor unit AC-PUHZ (always 1+1 in each system)	CoolTeg XC indoor unit + refrigerant piping system + outdoor condenser (always 1+1 in each system)
Coolant	Water/antifreeze mixture of glycol	Refrigerant R410A	Refrigerant R410A
System size	Unlimited	Limited by maximal distance and height difference	Limited by maximal distance and height difference
CAPEX	Reasonable for bigger systems (over 50 kW)	Reasonable for smaller systems (up to 120 kW)	Reasonable for mid-sized systems (up to 200 kW)
OPEX	Very low, due to variable temperature of water and free-cooling possibility	Higher, in comparison to CW system	Higher, in comparison to CW system
Advantage	Free-cooling possibility	Simple installation with compressor outside	For wide ambient temperature limits (from -40 °C up to +55 °C); quiet outdoor unit

# COOLTEG PLUS COOLING UNITS



➤ **CoolTeg** equipment represents a family of precision cooling units specifically designed for easy integration between IT racks. These air conditioning units – with various cooling principles, sizes and capacities – are Conteg's main product line for effective targeted cooling, from server rooms to large data centers.



## MAIN ADVANTAGES

- Small occupied floor area
- Brings chilled air directly to server rack
- Very low power consumption, due to modern components and control software
- Modern "server-friendly" control system
- Simple communication with operator
- Flexibility of room arrangement
- Easy installation in open or closed architecture
- Raised floor unnecessary for air distribution
- Perfect compatibility with Conteg IT racks
- Wide range of accessories (see page 86)

## SUITABLE FOR

- Open Aisles
- Contained Cold Aisle
- Contained Hot Aisle
- Modular Closed Loop – high capacity cooling system, where air is recirculated inside the rack and no heat is released into the environment

COLOR SAMPLER:  RAL 9005

 RAL 7035

## DESCRIPTION:

- Radial fans (with EC motors) for lowest energy consumption and precise control of airflow to servers
- High-efficiency copper-aluminium heat exchangers; also useful for Free-cooling systems
- Controller with special Conteg software, based on long-term experience from worldwide data centers
- 4.3" color touch-screen display for user-friendly communication

- One display operating up to 16 units per group
- Independent unit control as well as CoolTeg group control functions for entire row of racks
- Wide range of settings adjust performance to specific project
- Communication through TCP/IP protocol (standard)
- Easy ModBUS and remote management from any computer connected to Internet (via integrated Webserver)
- Other protocols available

- Humidity sensors in both cold and hot zones
- Humidification and dehumidification mode in each unit
- Four temperature sensors per unit

### Three cooling systems:

- CW – chilled water system
- DX – direct expansion system with compressor (in outdoor unit)
- XC – direct expansion system with compressor (within CoolTeg unit)



# COOLTEG PLUS CW



➤ **CoolTeg Plus CW** chilled water units are designed to be connected to any system with chillers producing cold water.

## MAIN ADVANTAGES

- Unlimited number of units connectible to any single water system
- Free-cooling system conserves ample amounts of energy
- Variable chiller types fulfill any requirements (outdoor noise level, extreme ambient temperatures, etc.)
- Water temperatures variable during the year, conserving energy while controlling humidity levels
- Maintains water temperature between 6 °C and 30 °C

COLOR SAMPLER:  RAL 9005

RAL 7035

CoolTeg Plus CW				
		CW30	SuperC	CW60
Indoor unit code	Unit	AC-TCW-42-30/XX-XXX	AC-TCW-42-30/XX-XXX	AC-TCW-42-60/XX-XXX
Connected outdoor unit code		Chilled water system		
<b>BASIC DATA</b>				
Cooling system	-	Chilled water		
Architecture <sup>1</sup>	-	Open or closed	Open	Open
Nominal cooling capacity <sup>2</sup>	kW	27.4	38.2	61.0
Nominal net cooling capacity <sup>3</sup>	kW	26.6	35.7	58.2
Power supply	V/ph/Hz	230/1/50	230/1/50	400/3/50
Running current	A	4.2	10.8	4.8
Maximum current	A	6	12	6
Nominal power consumption	W	770	2450	2900
Nominal airflow <sup>4</sup>	m <sup>3</sup> /h	3800	6000	10500
Number of fans	Pcs	5	5	3
Motor fan technology	-	EC		
Water flow	kg/h	3900	5200	8800
Filter class <sup>5</sup>	-	G4		
<b>DIMENSIONS</b>				
Height <sup>6</sup>	mm (U)	1978 (42U), 2111 (45U), 2245 (48U)		
Width	mm	300	300	600
Depth <sup>7</sup>	mm	1000 or 1200		
Weight – depth 1000 mm, height 42/45/48U	kg	163/168/173	164/169/174	248/256/264
Weight – depth 1200 mm, height 42/45/48U	kg	173/179/185	174/180/186	260/270/280
<b>PIPING CONNECTION</b>				
Supply pipe diameter and type	-	5/4" female	5/4" female	6/4" female
Return pipe diameter and type	-	5/4" female	5/4" female	6/4" female

<sup>1</sup> CoolTeg units can be used either independently (in rack rows) or integrated in Modular Closed Loop (MCL) – closed architecture rack systems and cooling units; Code changed as per ordering matrix

<sup>2</sup> Cooling capacity is changed by controller; nominal cooling capacity is calculated at return hot air temperature of 35 °C without condensation (air humidity below dew-point), chilled water temp. 6/12 °C (for CW)

<sup>3</sup> Net cooling capacity is the cooling capacity minus fan heat load - the actual unit cooling capacity available to IT equipment

<sup>4</sup> Airflow is changed by the controller; nominal airflow matches nominal cooling capacity

<sup>5</sup> Units in Modular Closed Loop architecture (MCL) are delivered without filters

<sup>6</sup> Without plinth or transport trolley

<sup>7</sup> Units for Modular Closed Loop architecture (MCL) are available in 1200 mm depth only

# COOLTEG PLUS DX



➤ **CoolTeg Plus DX** units work on the direct expansion principle, with refrigerant circulating between one indoor and one outdoor unit (equipped by compressor).

## MAIN ADVANTAGES

- Independent indoor and outdoor unit systems ensure 100% redundancy
- Easy installation and additional capacity expansion
- Keeps data center free of water
- Ecological refrigerant R410A

COLOR SAMPLER:  RAL 9005

RAL 7035

CoolTeg Plus DX				
		DXSmall	DX12	DX20
Indoor unit code	Unit	AC-TDS-42-30/XX-XXX	AC-TDX-42-30/XX-XXX	AC-TDX-42-30/XX-XXX
Connected outdoor unit code		AC-PUHZ-ZRP71V	AC-PUHZ-ZRP125Y	AC-PUHZ-ZRP200Y
<b>BASIC DATA</b>				
Cooling system	-	Direct expansion		
Architecture <sup>1</sup>	-	Open or closed	Open or closed	Open or closed
Nominal cooling capacity <sup>2</sup>	kW	7.0	12.1	19.0
Nominal net cooling capacity <sup>3</sup>	kW	6.8	11.9	18.0
Power supply	V/ph/Hz	230/1/50	230/1/50	230/1/50
Running current	A	0.7	1.2	4.2
Maximum current	A	6	6	6
Nominal power consumption	W	150	250	770
Nominal airflow <sup>4</sup>	m <sup>3</sup> /h	2100	2500	3800
Number of fans	Pcs	3	5	5
Motor fan technology	-	EC		
Refrigerant type	kg/h	R410A		
Filter class <sup>5</sup>	-	G4		
<b>DIMENSIONS</b>				
Height <sup>6</sup>	mm (U)	1978 (42U), 2111 (45U), 2245 (48U)		
Width	mm	300	300	300
Depth <sup>7</sup>	mm	1000 or 1200		
Weight – depth 1000 mm, height 42/45/48U	kg	153/158/163	163/168/173	163/168/173
Weight – depth 1200 mm, height 42/45/48U	kg	163/169/175	173/179/185	173/179/185
<b>PIPING CONNECTION</b>				
Supply pipe diameter and type	-	10 mm braze	10 mm braze	10 mm braze
Return pipe diameter and type	-	16 mm braze	22 mm braze	22 mm braze

<sup>1</sup> CoolTeg units can be used either independently (in rack rows) or integrated in Modular Closed Loop (MCL) – closed architecture rack systems and cooling units; Code changed as per ordering matrix

<sup>2</sup> Cooling capacity is changed by controller; nominal cooling capacity is calculated at return hot air temperature of 35 °C without condensation (air humidity below dew-point), outdoor temp. +35 °C, clean filters

<sup>3</sup> Net cooling capacity is the cooling capacity minus fan heat load - the actual unit cooling capacity available to the IT equipment

<sup>4</sup> Airflow is changed by the controller; nominal airflow matches nominal cooling capacity

<sup>5</sup> Units in Modular Closed Loop architecture (MCL) are delivered without filters

<sup>6</sup> Without plinth or transport trolley

<sup>7</sup> Units for Modular Closed Loop architecture (MCL) are available in 1200 mm depth only

## TECHNICAL DATA – DIRECT EXPANSION OUTDOOR UNITS

BASIC DATA	Unit	AC-PUHZ-ZRP71V	AC-PUHZ-ZRP125Y	AC-PUHZ-ZRP200Y
Nominal cooling capacity <sup>1</sup>	kW	7.1	12.5	19.0
Power supply	V/ph/Hz	230/1/50	400/3/50 <sup>2</sup>	400/3/50
Running current	A	7.63	5.93	7.77
Maximum current	A	19	9.5	19
Nominal power consumption	kW	1.72	3.78	5.46
Compressor control	-	Inverter		
Refrigerant control	-	Linear expansion valve		
Refrigerant R410A volume	kg	3.5	5.0	7.1
<b>DIMENSIONS</b>				
Width	mm	950	1050	1050
Depth	mm	330	330	330
Height	mm	943	1338	1338
Weight	kg	67	126	135
<b>PIPING CONNECTIONS</b>				
Liquid pipe (diameter)	mm	10	10	10
Gas pipe (diameter)	mm	16	16	22
Max. piping length	mm	50	75	100
Max. height difference	mm	30	30	30

<sup>1</sup> Data valid for nominal conditions: Outdoor temperature: 35 °C DB, Indoor temperature: 27 °C DB, Refrigerant piping length: 7.5 m, Outdoor temperature range: -15 °C to +46 °C

<sup>2</sup> AC-PUHZ-ZRP125 outdoor condensing unit demands power supply: 400 V/3 ph/50 Hz, one-phase units also available

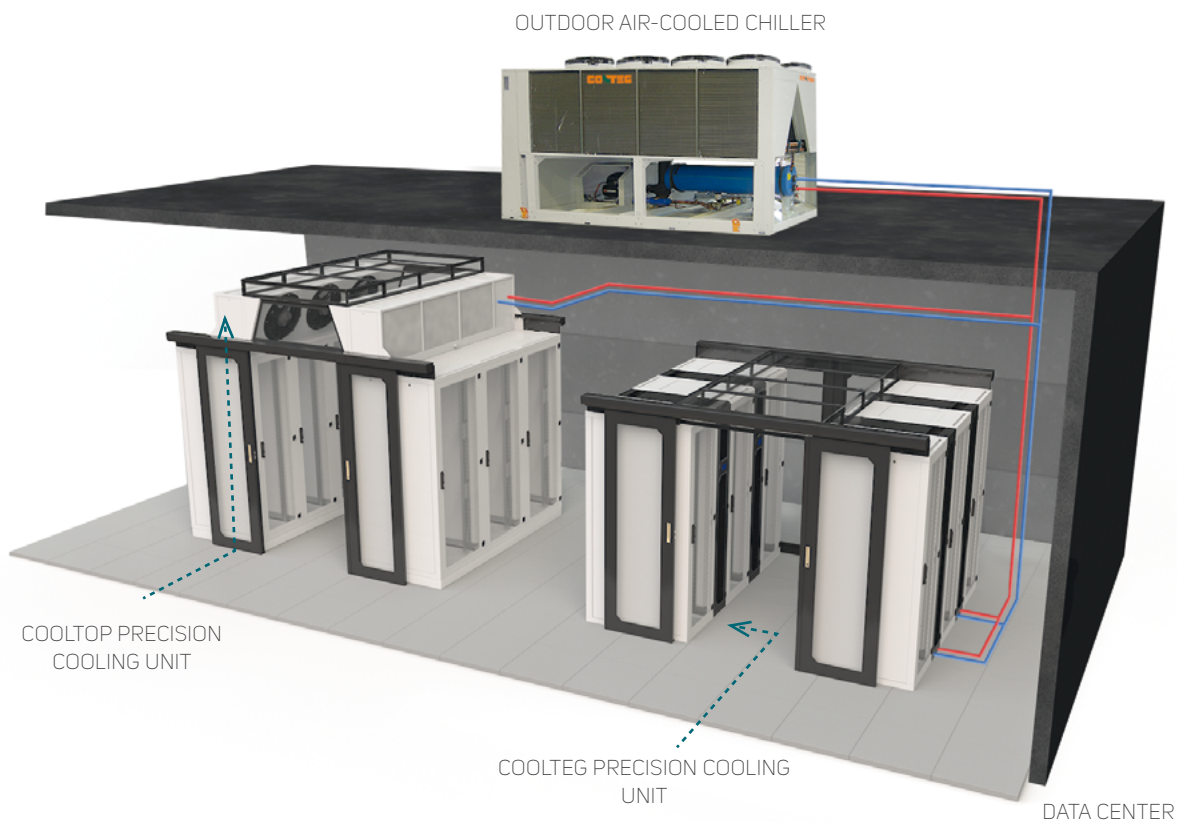

# COOLTEG PLUS XC



COLOR SAMPLER:

■ RAL 9005

■ RAL 7035

DESCRIPTION:

- The most efficient compressor to date
- Inverter-driven compressor built into internal unit
- Environmentally-friendly refrigerant R410a
- Electronic expansion valve and advanced steering logic
- Steplless capacity control from 20 to 100%
- Oil separator and Trax-oil inside
- Low- and high-pressure safety switches
- Refrigerant valves for easy maintenance

➤ **CoolTeg Plus XC** in-row units are based on the direct expansion principal. A compressor is integrated into the indoor unit, which is connected to its outdoor condenser.

## MAIN ADVANTAGES

- Keeps data center free of water
- Compressor safely positioned inside data center
- Very high energy efficiency and steplless capacity control
- Low noise of outdoor unit
- Variable design and size of outdoor unit
- Operation in wide range of outdoor temperatures
- Perfect oil management for piping system
- Ecological refrigerant R410A

CoolTeg Plus XC		
Indoor unit type	Unit	AC-TXC-42-40/XX-XXX
Connected outdoor unit		AC-COND2-xx-xx/EcoCool
<b>BASIC DATA</b>		
Cooling system	-	Direct expansion
Architecture <sup>1</sup>	-	Open or closed
Nominal cooling capacity <sup>2</sup>	kW	42.2
Nominal net cooling capacity <sup>3</sup>	kW	39.1
Power supply	V/f/Hz	400/3/50
Running current	A	22.7
Maximum current	A	25.3
Fan power consumption (maximum)	kW	3.1
Compressor power consumption (maximum)	kW	12.3
Nominal airflow <sup>4</sup>	m <sup>3</sup> /h	9000
Number of radial fans	Pcs	3
Motor fan technology	-	EC
Refrigerant type	-	R410A
Filter class <sup>5</sup>	-	G4
<b>DIMENSIONS</b>		
Height	mm (U)	1978 (42U), 2111 (45U), 2245 (48U)
Width	mm	400
Depth <sup>6</sup>	mm	1000 or 1200
Weight – depth 1000 mm, height 42/45/48U	kg	262/270/278
Weight – depth 1200 mm, height 42/45/48U	kg	274/284/294
<b>CONNECTION DIMENSION</b>		
Piping diameter – liquid line	mm	16
Piping diameter – gas line	mm	22

<sup>1</sup> CoolTeg Plus units can be used either independently (in rack rows), or integrated in a Modular Closed Loop (MCL) – closed architecture rack systems and cooling units. Indoor unit type is changed as per ordering matrix.

<sup>2</sup> Cooling capacity is changed by controller. Nominal cooling capacity is calculated at indoor hot air temperature 35 °C without condensation (air humidity below dew-point), outdoor temp. +35 °C, clean filters.

<sup>3</sup> Net cooling capacity is the total cooling capacity reduced for fan heat load. Useful unit cooling capacity.

<sup>4</sup> Airflow is automatically changed by controller. Nominal airflow matches nominal cooling capacity.

<sup>5</sup> Units in Modular Closed Loop architecture (MCL) are delivered without filters (standard)

<sup>6</sup> Units in Modular Closed Loop architecture (MCL) are available in 1200 mm depth only

- Operation in outdoor temperatures between -40 °C and +55 °C
- Distance between indoor and outdoor unit up to 60 m

### Outdoor unit

- Internal CoolTeg Plus XC unit compatible with any outdoor condenser with variable airflow
- Outdoor unit for heat rejection should be designed based on the condensing

temperature of the refrigerant, plus typical max. regional ambient temperatures

- For correct design of outdoor unit, please use our Cool Tool selection software or contact our team of technical specialists
- Local conditions determine which of Conteg's wet or dry (adiabatic) coolers can be deployed
- Conteg is currently developing a new adiabatic cooling unit, EcoCool (compatible with CoolTeg Plus XC), to reduce overall cooling system power consumption

## FOLLOW THE STEPS TO SET UP THE DESIRED COOLTEG PLUS UNIT CODE!

**AC - 1. - 2. - 3. / 4. 5. - 6. 7. 8.**

An example of a correct Code:

**AC - TCW - 42 - 30 / 12 A - T O D**

1. CoolTeg Plus COOLING SYSTEM	
Code	Options
TCW	Chilled water
TDX	Direct expansion
TDS	DXSmall direct expansion
TXC	Integrated compressor

2. HEIGHT*		
Code	Height (in U)	External height (mm)
42	42	1978
45	45	2111
48	48	2245

\* Without plinth and transport trolley

3. WIDTH	
Code	Width (mm)
30	300
40	400*
60	600**

\* For XC unit only

\*\* For CW unit only

4. DEPTH	
Code	Depth (mm)
10	1000 mm
12	1200 mm

5. GENERATION	
Code	Options
O	First generation
A	Second generation

6. CONNECTION	
Code	Options
T	Top
B	Bottom

7. ARCHITECTURE	
Code	Options
O	Open architecture
C	Closed architecture – MCL

8. DISPLAY	
Code	Options
D	Door display
W	Without display

## BASIC ACCESSORIES FOR COOLTEG PLUS AND COOLTOP COOLING UNITS

### PRESSURE CONTROL

- Each unit can control airflow based on temperatures in hot and cold zones
- For better airflow control in contained DC layouts (Contained Hot Aisle, Contained Cold Aisle or Modular Closed Loop), grouped CoolTeg Plus and CoolTop units should be equipped with a Pressure Control accessory, consisting of an Electrical cabinet (with controller, differential pressure meter and power supply)
- Airflow control ensures a perfect environment for servers (no risk of server damage caused by over- or under-pressure)
- Pressure control minimizes power consumption of the entire cooling system due to precision-dispensed conditioned air

### TCP2SNMP CONVERTER

- All Conteg precision cooling units can be controlled and monitored individually via free contacts
- Additionally, each unit can be equipped with a special communication card for ModBus RTU, SNMP, BacNet or other protocols
- Typically, the most direct method of communication is via group controller (multifunctional touch-screen display). Mod Bus TCP is the standard communication protocol
- Our specially developed TCP2SNMP converter enables the entire group of units to be maintained via group controller with SNMP protocol. It also offers a special web interface for easy group overview

### CONDENSATE PUMP

- All Conteg precision cooling units can be connected to a standard gravity drainage system
- If such a system is not available under the cooling units, it is necessary to drain the condensate to a piping system located at the top
- Each CoolTeg or CoolTop unit can be equipped with a condensate pump to displace the water from the condensate pan to the drainage pipe network
- Each unit includes a water level sensor to signal drainage problems or to start the pump (exact function depends on specific setting)

### DUAL POWER SUPPLY

- Electrical switchboard for two power supply systems

### HUMIDIFIER (FOR COOLTEG PLUS)

- Each CoolTeg Plus unit includes two humidity sensors, enabling control of the environment
- Dehumidification mode standard for all units
- For increasing air humidity, unit must be equipped with humidifier
- Electrode steam humidifier with maximal capacity 2 kg/hour
- Precise control of steam production, from 0–100%
- Suitable for standard tap water
- Humidifier available in all CoolTeg Plus types and sizes

### “PCO WEB” COMMUNICATION CARD

- Accessory compatible with CoolTeg Plus and CoolTop controllers
- Enables additional individual communication (monitoring and control)
- Communication via Ethernet network protocols
- Functions: Web server, E-mail, FTP, SNMP, BACNet, ModBus TCP/IP and others

# TARGETED COOLING & AIRFLOW MANAGEMENT

## COOLTOP COOLING UNITS



➤ **CoolTop** cooling units are specifically designed for easy installation atop IT racks, and are uniquely suitable for effective targeted cooling of server rooms and large data centers.

### MAIN ADVANTAGES

- Does not occupy floor area
- Brings chilled air directly to cold aisle in front of server racks
- Vertical air loop, with local flexibility
- Extremely low power consumption, due to large heat exchanger and EC axial fans
- Modern "server-friendly" control system
- Allows flexibility of room arrangement
- Raised floor unnecessary for air distribution
- Installs easily in contained hot or cold aisle
- Perfectly compatible with Conteg IT racks
- Comes with a wide range of accessories (see page 86)

COLOR SAMPLER:  RAL 9005  RAL 7035

### SUITABLE FOR

- Contained Cold Aisle
- Contained Hot Aisle
- Can be combined with CoolTeg Plus units in the same group (aisle)

CoolTop			
		CoolTop2	CoolTop3
Indoor unit code	Unit	AC-TOP2-CW-240/60	AC-TOP3-CW-240/60
Connected outdoor unit		Chilled water system	
<b>BASIC DATA</b>			
Cooling system	-	Chilled water	
Architecture	-	Open	Open
Nominal cooling capacity <sup>1</sup>	kW	37.0	48.0
Nominal net cooling capacity <sup>2</sup>	kW	36.3	46.9
Power supply	V/ph/Hz	230/1/50	
Running current	A	3.4	5.0
Maximum current	A	4.6	6.8
Nominal power consumption	W	710	1100
Nominal airflow <sup>3</sup>	m <sup>3</sup> /h	7700	11000
Number of fans	Pcs	2	3
Motor fan technology	-	EC	
Water flow	kg/h	6200	8200
Filter class	-	G2 (+ droplet separator)	
<b>DIMENSIONS</b>			
Height <sup>4</sup>	mm	600	
Width	mm	2400	
Depth <sup>5</sup>	mm	400 (600)	
Weight <sup>6</sup>	kg	175	184
<b>PIPING CONNECTION</b>			
Supply pipe diameter and type	-	6/4" female	
Return pipe diameter and type	-	6/4" female	

<sup>1</sup> Cooling capacity can be changed via electronic controller. Nominal cooling capacity is stated for air temperature of 35 °C in hot zone, without condensation (relative humidity under dew point). Water temperature is 10/15 °C, clean filters.

<sup>2</sup> Net cooling capacity (without heat from fans) is usable cooling capacity of entire system

<sup>3</sup> Airflow is changed by control needs. Nominal airflow equals nominal cooling capacity.

<sup>4</sup> Without any base frame

<sup>5</sup> Bottom side length 400 mm; top side length 600 mm

<sup>6</sup> For weight with droplet separator, add 11 kg



# TARGETED COOLING & AIRFLOW MANAGEMENT

## VENTILATION UNITS

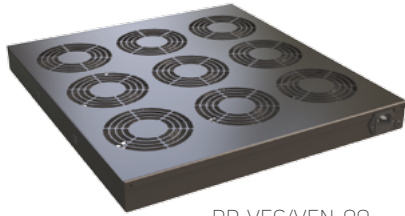

DP-VEC/VEN-09



DP-VEC/VEN-06

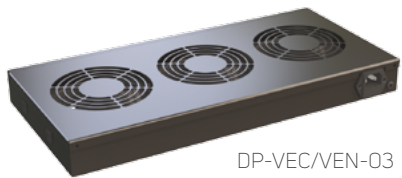

DP-VEC/VEN-03

Once installed within Conteg cabinets, IT components require sufficient airflow to help them remain cool and functioning properly. When sufficiently cool environments cannot be sustained, they require assistance: installing Conteg ventilation units. We offer different styles, sizes, types and accessories – we've even developed DP-VEC units with highly efficient EC fans, to reduce operation costs.

### EC TECHNOLOGY:

Efficient, ecological and economical! New high-quality fans (produced in Europe by the reputable Ebm-papst) feature electronically commuted (or EC) synchronic motors, which offer very low power consumption in comparison to standard AC motors. In fact, power consumption of our new DP-VEC ventilation unit is seven times lower than the standard DP-VEN, which has equal airflow. Additionally, our DP-VEC provides up to 60% more airflow (with an equal number of fans and required air pressure) than DP-VEN.

Code	Airflow (m³/h)	Rated current max. (A)	Power consumption (W)	Annual power consumption <sup>1</sup> (kWh/year)	Possible heat removal <sup>2</sup> (kW)	Package
<b>STANDARD AC FANS</b> Specific Fan Power (SFP) = 611 W/(m³/s)						
DP-VEN-02	224	0.180	38	333	0.38	1 pc
DP-VEN-03	336	0.270	57	499	0.57	1 pc
DP-VEN-04	448	0.360	76	666	0.76	1 pc
DP-VEN-06	672	0.540	114	999	1.14	1 pc
DP-VEN-09	1008	0.810	171	1498	1.71	1 pc
<b>HIGH-END EC FANS</b> Specific Fan Power (SFP) = 88 W/(m³/s)						
DP-VEC-03	540	0.057	13.2	116	0.92	1 pc
DP-VEC-06	1080	0.114	26.4	231	1.84	1 pc
DP-VEC-09	1620	0.171	39.6	347	2.75	1 pc

<sup>1</sup> For non-stop operation

<sup>2</sup> If temperature difference between intake and exhaust air from the rack is  $\Delta t=5$  K

Ventilation unit type	Connecting kit for installation in top or bottom frame of free-standing racks			
	600, 800 or 1200 mm depth		1000 mm depth	
	Without filter	With filter	Without filter	With filter
DP-VEx-02, 03	DP-VER-03	DP-VER-03F	DP-VER-031	DP-VER-031F
DP-VEx-04, 06	DP-VER-06	DP-VER-06F	DP-VER-061	DP-VER-061F
DP-VEx-09	-	-	DP-VER-091	DP-VER-091F

Replace x with N or C

### DESCRIPTION:

- Used to force airflow through a rack to assist with cooling
- Two to nine fans
- Installation variables:
  - a) In 19" extrusions – horizontally
  - b) In top or bottom frame of free-standing rack
- Connecting kit for ventilation unit needed when installing in top or bottom frame

- Temperature range: -10 °C to +55 °C
- Thermostat ranges from 0–60 °C included (no thermostat optional)
- Voltage range 230 V/50–60 Hz (48V DC optional)
- Protection category: to EN 60 529, IP 20
- Color: powder-coated RAL 9005
- Standard solution with AC fans DP-VEN-XX

- High-end version with most efficient EC fans DP-VEC-XX
- Package includes:
  - Ventilation unit with 19" brackets
  - Thermostat
  - Power supply cable
  - DP-MO-01 installation set

## FANS

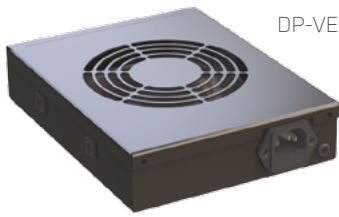

DP-VE-01

- Forces air through racks
- Two versions
  - With thermostat and metal chassis – DP-VE-01 (for -VC openings)
  - Without thermostat and metal chassis – DP-VE-01 (for -VH or -TH openings)

Code	Airflow (m <sup>3</sup> /h)	Rated current max. (A)	Power consumption (W)	Annual power consumption <sup>1</sup> (kWh/year)	Possible heat removal <sup>2</sup> (kW)	Package
<b>STANDARD AC FANS</b>						
Specific Fan Power (SFP) = 611 W/(m <sup>3</sup> /s)						
DP-VE-01	112	0.09	19	166	0.19	1 pc
DP-VE-01	112	0.09	19	166	0.19	1 pc

<sup>1</sup> For non-stop operation

<sup>2</sup> If temperature difference between intake and exhaust air from rack is  $\Delta t=5$  K

- Can be installed either on side or top of wall-mounting rack
  - Special perforation needed – ordering code to be extended:
    - VH for 2× side perforation or TH for 2× top cover perforation; both for DP-VE-01 only
    - VC for 2× center-oriented holes for DP-VE-01
  - In top or bottom frame of distribution rack, requires perforated gland plate DP-VE-ROV2 or DP-VE-ROV4
- Package includes:
  - DP-VE-01: Fan with grid, power cable, 8× screws, 8× nuts
  - DP-VE-01: Fan in-house, power cable, thermostat, 4× screws, 4× nuts

## LITE VENTILATION UNIT



DP-VEL-04

- Forces air through racks to assist with cooling
- Two or four AC fans
- Can be installed in either top or bottom frame of free-standing rack
- Connecting kit for ventilation unit (included)
- Temperature range: -10 °C to 55 °C
- Thermostat range (if included): 0 °C to 60 °C
- Voltage range 230 V / 50–60 Hz
- Protection category: EN 60529, IP20
- Color: powder-coated RAL 9005
- Package includes:
  - Ventilation unit with mounting plate
  - Thermostat (if part of model)
  - Power supply cable
  - Installation set: 4x screws, 4x nuts

Code	Description	Package
DP-VEL-02	Ventilation unit, 2 fans, with thermostat, for top or bottom installation into racks with depths of 600, 800 and 1200 mm	1 pc
DP-VEL-02B	Ventilation unit, 2 fans, without thermostat, for top or bottom installation into racks with depths of 600, 800 and 1200 mm	1 pc
DP-VEL-02/100	Ventilation unit, 2 fans, with thermostat, for top or bottom installation into racks with depths of 1000 mm	1 pc
DP-VEL-02B/100	Ventilation unit, 2 fans, without thermostat, for top or bottom installation into racks with depths of 1000 mm	1 pc
DP-VEL-04	Ventilation unit, 4 fans, with thermostat, for top or bottom installation into racks with depths of 600, 800 and 1200 mm	1 pc
DP-VEL-04B	Ventilation unit, 4 fans, without thermostat, for top or bottom installation into racks with depths of 600, 800 and 1200 mm	1 pc
DP-VEL-04/100	Ventilation unit, 4 fans, with thermostat, for top or bottom installation into racks with depths of 1000 mm	1 pc
DP-VEL-04B/100	Ventilation unit, 4 fans, without thermostat, for top or bottom installation into racks with depths of 1000 mm	1 pc

Code	Airflow (m <sup>3</sup> /h)	Rated current max. (A)	Power consumption (W)	Annual power consumption <sup>1</sup> (kWh/year)	Possible heat removal <sup>2</sup> (kW)
DP-VEL-02	224	0.180	38	333	0.38
DP-VEL-04	448	0.360	76	666	0.76

<sup>1</sup> For non-stop operation

<sup>2</sup> If temperature difference between intake and exhaust air from rack is  $\Delta t=5$  K

# AIRFLOW MANAGEMENT PRODUCTS

➤ Mechanical separation of hot and cold air in data centers leads to higher energy and power efficiency. Proper separation of the two zones will help achieve both lower temperatures for computers and higher temperatures for cooling machines.

## CONTAINED AISLE



SLIDING DOORS

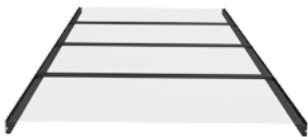

ROOF PANELS

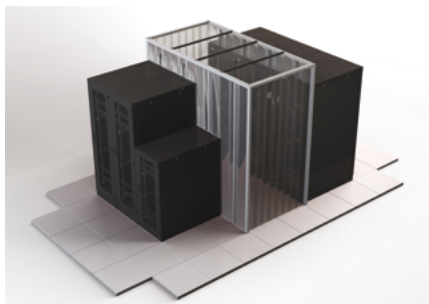

MODULAR SOLUTION - MCA

### CONTAINED AISLE – FIXED SOLUTION

#### Door sections

- Sliding door options:
  - a) A standard mechanical operating system (each door wing independent)
  - b) A dual synchro system (both door wings moving simultaneously)
  - c) An automatic system with electronic opening and closing (via buttons)
  - d) An automatic system with Full logic (controlled opening, automatic closing)
  - e) A self-closing system (via mechanical system)
- A blank panel can be used instead of doors to close one side of contained aisle

#### Roof

- Solutions available for 42, 45, and 48U racks and for 1000, 1200 and 1800 mm wide aisles
- Roof sections (available in 400, 600, 800, 900 & 1100 mm) are bolted onto top of racks to prevent mixing of cold air and warm exhaust; 1.5 mm sheet steel frame
- Vertical sections feature an insert panel to accommodate same-height racks
- 6 mm clear polycarbonate roof panels allow for easy integration of fire suppression systems into the cold aisle; optional polycarbonate multiwall

### CONTAINED AISLE – MODULAR SOLUTION

- The Modular Contained Aisle system is the ideal solution for retrofit projects where rows of racks with different heights or gaps (when some racks are missing) are required
- Based on a self-supporting design with either clear or multiwall polycarbonate panels on top of roof

- Vertical side roof sections feature flexible PVC foil strips, which can be easily cut to required length
- Modular Contained Aisle is equipped with flexible PVC foil strips in place of door
- Available in heights of 2300 and 2500 mm

For more information, please contact our sales or technical team [www.conteg.com/contacts](http://www.conteg.com/contacts)

## 19" BLANK AND FAST BLANK PANELS

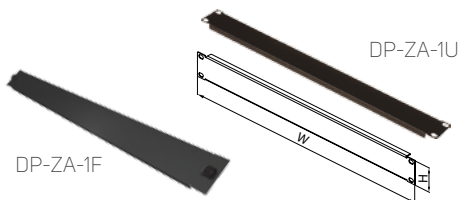

- Cover empty positions in rack to minimize by-pass airflow, increase energy efficiency and enhance aesthetic appearance
- Heights: 1, 2, 3, 5, 10 and 15U
- Color: powder-coated RAL 9005
- Tool-less solution uses quarter-turn fasteners
- Package includes:
  - DP-ZA-XU: blank panel
  - DP-ZA-XF: blank panel with fasteners

Code	H (in U)	Width	Package
DP-ZA-1U	1	19"	5 pcs
DP-ZA-2U	2	19"	5 pcs
DP-ZA-3U	3	19"	5 pcs
DP-ZA-5U	5	19"	5 pcs
DP-ZA-1F	1	19"	5 pcs
DP-ZA-2F	2	19"	5 pcs
DP-ZA-3F	3	19"	5 pcs
DP-ZA-5F	5	19"	5 pcs

For tool-less design use code with suffix F

## AIR SEPARATION FRAME

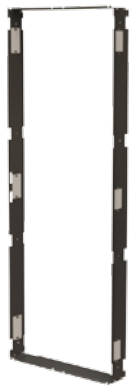

AIR SEPARATION FRAME

- Minimize bypass airflow between a rack's hot and cold zones, improving efficiency in support of contained aisle solutions
- Color: powder-coated RAL (standard RAL 7035 or 9005)
- Package includes:
  - Set 1: 2x vertical parts, 2x horizontal parts
  - Set 2: 2x horizontal parts, 1x brush for vertical parts

Code	Cold zone depth (mm)	H (in U)	Applicable for	W (mm)	Compatible extrusions	Package
DP-ROF-CW-42/80/15 <sup>1</sup>	150	42	RDF, RFS	800	L-type, P-type (RSF)	1 pc of set 1
DP-RSF-CW-42/60/15 <sup>1</sup>	150	42	RSF	600	T-type	1 pc of set 1
DP-RSF-CW-42/80/15 <sup>1</sup>	150	42	RSF	800	U-type	1 pc of set 1
DP-RSF-CWA-42/60 <sup>1</sup>	Variable	42	RSF, iSEVEN SERVER	600	A-type	1 pc of set 1
DP-RSF-CWA-42/80 <sup>1</sup>	Variable	42		800	A-type	1 pc of set 1
DP-RXF-CW-48/60/5	50	42-48	RSF, iSEVEN	600	L-type	1 pc of set 2
DP-RXF-CW-48/80/5	50	42-48	RSF, RDF, iSEVEN	800	L-type	1 pc of set 2

<sup>1</sup>Height (42U) can be replaced by 45 or 48U

## AIRFLOW DEFLECTOR



AIRFLOW DEFLECTOR WITH LOUVRE FOR RDF RACK

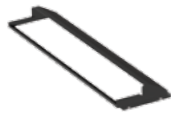

AIRFLOW DEFLECTOR FOR RDF/RSF RACK

- Located in the bottom of the rack, deflectors are used to deflect air intake from the raised floor toward the front of the rack, directing cold air into the cold zone
- Package includes:
  - DP-AFD-ROF-80/XXX/15: 1x deflector, 1x cable gasket, 4x nuts, 4x washers
  - DP-AFD-VF-XX: 1x louvre, 4x DP-MO-01
  - DP-AFD-RSF-XX/15: 1x deflector, 4x nuts, 4x washers

Code	Height	D (mm)	Applicable	W (mm)	Package
DP-AFD-ROF-80/80/15	2U	800, 1200	RDF	800	1 set
DP-AFD-ROF-80/100/15	2U	1000	RDF	800	1 set
DP-AFD-VF-80	Variable Flow Rate Louvre – 800		RDF	–	1 set
DP-AFD-RSF-60/15*	–	–	RSF	600	1 set
DP-AFD-RSF-80/15*	–	–	RSF/RDF	800	1 set

Note: Cold zone depth 150 mm

\* When used with A type extrusions, min. cold zone depth is 220 mm

## CHIMNEY



CHIMNEY

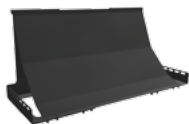

TURNING VANE

- Designed to lead hot exhaust air to the suspended ceiling; comes complete with gasket kits to ensure optimum sealing between rack and hot plenum; height can be adjusted from 750 to 1360 mm, according to site requirements.
- Turning vane is designed to enhance the natural draw effect of the chimney, allowing for cable passage; requires a min. of 200 mm offset on rear extrusions
- Package includes: top plate, chimney, turning vane

Code	Description	Package
DP-HPR-60/120-B	Designed for RSF-XX-60/120; color light gray (RAL 7035)	1 set
DP-HPR-60/120-H	Designed for RSF-XX-60/120; color black (RAL 9005)	1 set
DP-HPR-80/120-B	Designed for RDF/RSF-XX-80/120; color light gray (RAL 7035)	1 set
DP-HPR-80/120-H	Designed for RDF/RSF-XX-80/120; color black (RAL 9005)	1 set

## 19" VENTED PANEL

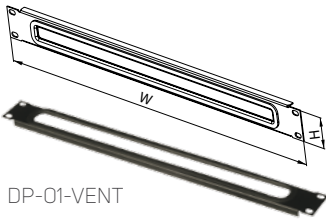

DP-01-VENT

- Enables front-to-rear cable passage through empty positions in rack
- Height: 1U
- Width: 19"
- Color: powder-coated RAL 9005

Code	H (in U)	Width	Package
DP-01-VENT	1	19"	1 pc

## 19" VENTED PANEL WITH BRUSH

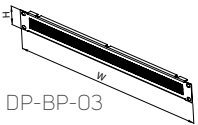

DP-BP-03

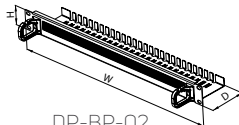

DP-BP-02

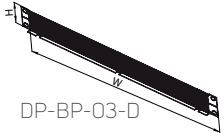

DP-BP-03-D



DP-BP-04

- Enables front-to-rear cable passage through empty positions in rack, while helping to minimize by-pass airflow
- Options:
  - a) With brush at one side DP-BP-04 – usable for 2U 19" openings at A type extrusions (2 pcs)
  - b) With brush DP-BP-03
  - c) With brush, divided - DP-BO-03-D
  - d) With brush and cable management DP-BP-02 – vented panel with brush and cable management (cable management bar on back and two 40x50 mm cable brackets on sides)
- Height: 1U
- Color: powder-coated RAL 9005

Code	H (in U)	Width	Depth (mm)	Package
DP-BP-02	1	19"	85	1 pc
DP-BP-03	1	19"	–	1 pc
DP-BP-03-D	1	19"	–	1 pc
DP-BP-04	1	19"	–	1 pc

# SIDE-TO-SIDE AIRFLOW SOLUTION (STS)



➤ Separating hot and cold air zones is the most effective means of improving data center efficiency, with a goal of reaching perfect hot/cold air separation in each rack. This is very difficult in racks with differing IT components, however, as varying airflow directions create major obstacles. Conteg has the solution for management of side-to-side direction components.

## MAIN ADVANTAGES

- Unique technical solution for data centers for side-to-side airflow equipment
- Allows a combination of several chassis with various airflow directions into one rack
- Maximal airflow volume capacity
- Increases computing capacity
- Designed for high-performance network products

Code	Product
<b>SIDE-TO-SIDE AIRFLOW SUPPORT</b>	
RSF-42-80/100-WWWWA-SE1	RSF, 42U×800×1000, S-t-S Airflow solution, Size 1
RSF-42-80/120-WWWWA-SE1	RSF, 42U×800×1200, S-t-S Airflow solution, Size 1
RSF-42-80/120-WWWWA-SE2	RSF, 42U×800×1200, S-t-S Airflow solution, Size 2

Heights of 45 and 48U available upon request

## DESCRIPTION:

- Width: 800 mm
- Depth: 1000 or 1200 mm
- Front and rear vented doors, 86% perforation, multipoint lock with DIN profile, key 333
- Load rating up to 1000 kg, depending on the frame type
- P-type extrusion on left front side, with possibility of vertical HDWM-VMR-42-12/10F installation
- Blank panels for side deflector included for all positions
- Frame for separation of hot and cold air space
- Clearance between chassis and side panels is 170 mm

- High Density Wire Management bar on right front side for effective cable management (standard)
- Enables installation of network components for specific data Center layouts:
  - Hot/Cold Aisle
  - Contained Aisle
  - Chimney Solution
  - Modular Closed Loop
- Air-flow supporting channel increases air volume for side air intake (when cable bundles could block network chassis)
- Adaptors must be ordered separately

- Enables combination of several types of network chassis in one rack; adapters for chassis need to be ordered separately
- Parts of network chassis allow cable management only on right side; can use with HDWM-HM-3F to guide cable bundles of cables on opposite sides above and below the chassis into another installed cable manager – HDWM-VMR-42-12/10F.
- Side extension kit increases rack width to allow more air volume for side air intake; necessary for some types of network chassis

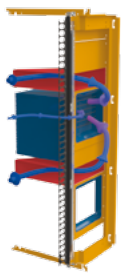

S-T-S WITH TWO AIRFLOW SUPPORTING CHANNELS

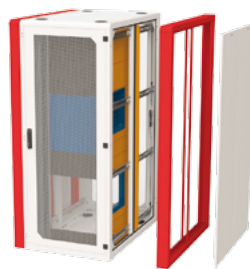

SIDE EXTENSION KIT 1200 MM DEPTH RACK

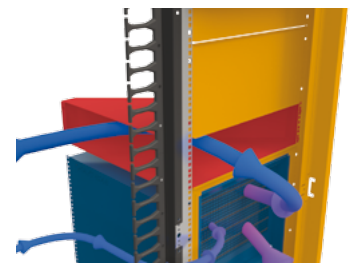

S-T-S WITH TWO AIRFLOW SUPPORTING CHANNELS

Side-to-Side Airflow Support - Accessories		
Code	Description	Package
DP-ST-S-EXT-2-42*	Side extension kit 100mm for Airflow support (rack height 42U, depth 1200 mm)	1 pc
DP-ST-S-EXT-2-45*	Side extension kit 100mm for Airflow support (rack height 45U, depth 1200 mm)	1 pc
DP-ST-S-EXT-2-48*	Side extension kit 100mm for Airflow support (rack height 48U, depth 1200 mm)	1 pc
DP-ST-S-1-SACH	Airflow supporting channel for chassis S-t-S - Size 1	1 pc
DP-ST-S-2-SACH	Airflow supporting channel for chassis S-t-S - Size 2	1 pc

\* Min. ordering quantity: 2 pcs



# 05

## COMPLEMENTARY SYSTEMS

<b>Rack Monitoring System</b>	96
RAMOS Ultra	97
RAMOS Optima	98
RAMOS Plus	98
RAMOS Mini	98
Accessories	99
<b>Access Control System (ACS)</b>	100
RAMOS Ultra ACS	100
Standalone Electronic Latches	101
<b>CONTEG Pro Server Management (Software)</b>	102
<b>AEGIS DCIM</b>	103
<b>Keyboard-Video-Mouse Solutions (KVM/LCD)</b>	104
<b>Local Extinguishing System (LES-RACK)</b>	105
<b>Intelligent &amp; Basic Power Distribution Units</b>	106
Basic Power	106
Intelligent Power – Monitored	107
Intelligent Power – Managed	108
Outlet and Plug Types	109

# RACK MONITORING SYSTEM

	RAMOS Ultra / Ultra ACS	RAMOS Optima	RAMOS Plus / Plus GSM	RAMOS Mini
	See pages 97/100	See page 98	See page 98	See page 98
Suitable for	DC and server rooms	Multiple cabinets or server room	Single or few cabinets	Single racks/Cabinets
Sensors	8x / 2x intelligent port (expandable up to 500 sensors)	8x intelligent ports	4x intelligent ports	1x IN, 1x OUT, up to 3 sensors (T&H)
Communication	LAN: SNMP v1, v2 & v3; VPN; Modbus GSM: with plug-in GSM modem Serial: RS485 (Modbus only)	LAN: SNMP v1 & v2	LAN: SNMP v1, v2 & v3 GSM: GSM variant only	LAN: SNMP v1 & v2; XML
Notifications	Emails SNMP traps SMS* MMS* Call* Speech Skype call & SMS Relay control* Door control* Server restart / shutdown / wake-up And many more...	Emails SNMP traps Output control for dry contact* Siren & strobe* or external relay*	Emails SNMP traps Output control for dry contact* Siren & strobe* or external relay* (SMS & call-in variant with built GSM modem)	Emails SNMP traps Output control for Latch* Siren & strobe* or external relay*
Integration to CONTEG Pro Server	Free	Free	Free	Licensed
BENEFITS	Intelligent ports variability Expandable solution Monitoring of 3rd-party devices Sensor mapping	Intelligent ports variability	Intelligent ports variability Supports all intelligent accessories Variant with built-in GSM modem	Small and simple Manual relay control
<b>Parameters</b>				
Dimensions HxWxD	46x216x138 mm	46x216x138 mm	32x115x64 mm	28x66x66 mm
Voltage	7.5 V DC / 12 V DC	7.5 V DC	12 V DC	5 V DC
Power consumption	5.025 W, 0.67 A	1.12 W, 0.15 A	1/1.5 W, 0.1/0.125 A	1 W, 0.2 A

\* Requires appropriate accessories

## RAMOS ULTRA INSTALLATION WITH EXPANDERS

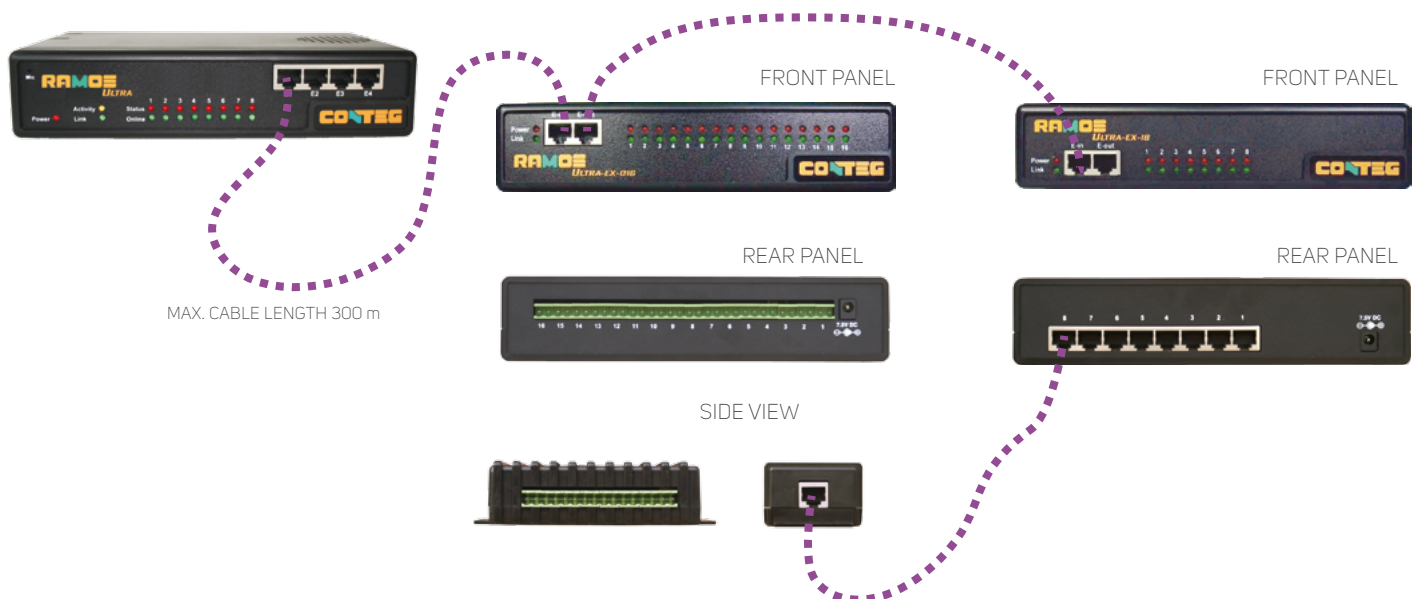

# RAMOS ULTRA



➤ **RAMOS Ultra** is an excellent, expandable monitoring solution for server rooms and data centers – an excellent choice for any design where sensor mapping, smart graphs, intelligent notification or a GSM gateway are required without external software/application. Includes a user-friendly web interface for sensor configuration, data collection and extensive graphing.

Code	Package includes
RAMOS ULTRA	Monitoring device RAMOS Ultra, power adapter with EU power cord, 1.5 m crossover patch cord, 1U high bracket with screws and installation CD
RAMOS ULTRA-EX-016	RAMOS Ultra Expander 016, power adapter with EU power cord, 1U high bracket with screws and 1.5 m LAN cable
RAMOS ULTRA-EX-18	RAMOS Ultra Expander 18, power adapter with EU power cord, 1U high bracket with screws and 1.5 m LAN cable
RAMOS ULTRA-EX-D64	RAMOS Ultra Expander D64, power adapter with EU power cord, 1U high bracket with screws and LAN cable 1.5 m
RAMOS ULTRA-EX-D128	RAMOS Ultra Expander D128, power adapter with EU power cord, 1U high bracket with screws and LAN cable 1.5 m
RAMOS ULTRA-EX-D192	RAMOS Ultra Expander D192, power adapter with power cord, 2U high bracket with screws and LAN cable 1.5 m

## DESCRIPTION:

- 8 auto-sense intelligent sensor ports; can be set to input or output
- Monitors up to 500 intelligent sensors using expansion modules (RAMOS Ultra-EX-016 and RAMOS Ultra-EX-18); daisy-chain connected to 4 expansion ports
- Max. 300 m connection cable (LAN Cat. 5/6) either between expander and RAMOS or between expanders
- Accessories powered via intelligent ports
- Sensors/detectors can be added to uploaded pictures/maps for improved visual monitoring
- Fully embedded TCP/IP and web server
- Internal Linux web-based interface for easy configuration and monitoring
- Network Management System integration
- User/administrator login for improved security (User & Group management)
- 80 virtual sensors for monitoring 3rd-part hardware (via Modbus, SNMP, ping and more)
- Integrates with network management systems via SNMP v1, v2 and Encrypted v3
- Full Modbus support: Modbus master/slave, Modbus RTU and Modbus TCP/IP
- Built-in graphing and data logging, internally or to remote PC
- PHP web-based interface allowing end-user changes (i.e. language translation)
- Battery-backed clock for accurate system date and time
- Clever notification features – email and SNMP traps, SMS/MMS, call, speech and many more
- Can access external GPRS/GSM modem, Bluetooth and Wi-Fi USB adapters

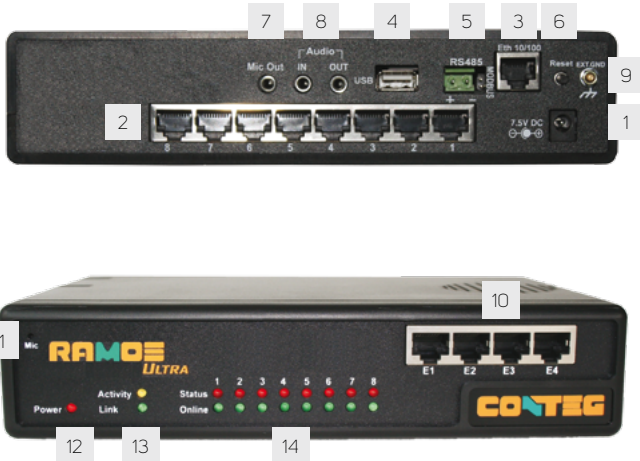

RAMOS Ultra – REAR VIEW	
1	7.5 V DC power input
2	8× intelligent sensor ports (RJ-45)
3	Standard 10/100 Base-T Ethernet
4	USB port 2.0 for GSM/GPRS, Bluetooth or Wi-Fi adapter
5	Modbus connectivity – RS485
6	Reset button
7	Output from int. microphone
8	Input for ext. microphone and output for ext. speaker
9	External ground

RAMOS Ultra – FRONT VIEW	
10	4× expansion ports
11	Internal microphone
12	Power indicating LED
13	Activity/link indicating LED
14	16 LEDs, indicating online status of connected sensors

## RAMOS Ultra / Ultra ACS EXPANDERS:

### RAMOS Ultra-EX-18

- Adds 8 intelligent ports for intelligent accessories

### RAMOS Ultra-EX-016

- Adds 16 opto-isolated dry contact inputs

### RAMOS Ultra-EX-D64

- Adds 64 dry contacts (IN/OUT) via 16 RJ-45 ports (each with 4 dry contacts)

### RAMOS Ultra-EX-D128

- Adds 128 dry contacts (IN/OUT) via 32 RJ-45 ports (each with 4 dry contacts)

### RAMOS Ultra-EX-D192

- Adds 192 dry contacts (IN/OUT) via 48 RJ-45 ports (each with 4 dry contacts)



## RAMOS OPTIMA



FRONT VIEW



REAR VIEW

➤ **RAMOS Optima** is an accurate, intelligent high-speed monitoring device suitable for one or more racks, where up to 8 intelligent ports are required.

Code	Package includes
RAMOS OPTIMA	RAMOS Optima monitoring device, 1× temperature sensor with 30 cm long cable, power adapter with power cord, 1.5 m crossover patch cord cable, 1U high bracket with screws and installation CD

RAMOS Optima	
1	LED power indicator
2	LED activity/link indicator
3	16 LEDs indicating online status of connected sensors
4	8× intelligent sensor ports (RJ-45)
5	Standard 10/100 Base-T Ethernet
6	7.5 V DC power input

### DESCRIPTION:

- 8 auto-sense intelligent sensor ports; can be set to either input or output
- All accessories powered via Intelligent ports
- Communication via SNMP v1 and v2
- Notification via email and SNMP traps

- Fully embedded TCP/IP and web server
- Internal Linux web-based interface for easy configuration and monitoring
- Battery-backed clock for accurate system date and time
- Syslog (internal/external) and history with sensor graphs
- Network management system integration
- Security login for user and administrator

## RAMOS PLUS



➤ **RAMOS Plus** is an entry model of the RAMOS intelligent range, designed for use in indoor and outdoor cabinets. Available in either standard or GSM options, the latter with a built-in GSM modem and external antenna. Four intelligent ports provide ample opportunity for multiple use. Improved intelligent ports support a full range of accessories, including RAMOS Ultra for intelligent ports.

Code	Package includes
RAMOS PLUS	RAMOS Plus monitoring device, power adapter, 1.5 m crossover patch cord cable, bracket with screws and installation CD

### DESCRIPTION:

- 4 auto-sense intelligent sensor ports; can be set to either input or output
- All accessories powered via Intelligent ports
- Communication via SNMP v1, v2 and v3

- Notification via email and SNMP traps
- Fully embedded TCP/IP and web server
- Syslog and history with sensor graphs
- Network management system integration
- Security login for user and administrator
- Optional built-in GSM modem available upon request

## RAMOS MINI



➤ **RAMOS Mini** is designed for deployment within a single rack, monitoring internal and external environments. Attached to a network, it reports the status of sensors deployed in and around racks to any location worldwide. Through the use of SNMP traps, it can fully integrate with any network management software.

Code	Package includes
RAMOS MINI	RAMOS Mini, up to 3 sensors (temperature and humidity), 1× IN, 1× OUT, incl. RMS-ST-02, RMS-PW-05, straight and angle holder, installation CD

### DESCRIPTION:

- Up to 3 temperature or humidity sensors (with new firmware)
- 1× dry contact input
- 1× output (relay switch contact up to 50 V DC)
- Two alert ranges per sensor
- Notification alarm via email and SNMP trap to several recipients

- Built-in graphic web interface for configuration and value monitoring
- Each sensor comes complete with unique ID
- Alarm updates via email and SNMP trap or SMS (over CONTEG Pro Server Software or 3rd-party software)
- Open communication protocols (web, email, SNMP, XML)
- Security: password
- Optional 255 data point graph view

# ACCESSORIES

## INTELLIGENT ACCESSORIES FOR RAMOS ULTRA, OPTIMA AND PLUS:

Code	Description	RAMOS		
		Ultra	Optima	Plus
RMS-I-ST	One wire temperature sensor with 30 cm cable; can be extended up to 30 m (Cat. 5/6 LAN) via Cat. 5 coupler (included)	+	+	+
RMS-I-STH	One wire temperature and humidity sensor with 30 cm cable. Humidity range 0–100%. Can be extended up to 30 m (Cat. 5/6 LAN) via CAT. 5 coupler (included).	+	+	+
RMS-I-STHB	One wire temperature and humidity sensor in Box with free 1.5 m LAN cable. Humidity range 0–100%. Can be extended up to 300 m (Cat. 5/6 LAN).	+	+	+
RMS-I-AF	Airflow sensor with attached 1.5 m LAN cable (Cat. 5). On/off airflow signal alarm.	+	+	+
RMS-I-AS	Siren & Strobe light with attached LAN cable (Cat. 5) 1.5 m. 100 db siren sound and flashing strobe interval 400x per minute. Cable can be extended up to 30 m (Cat. 5/6 LAN).	+	+	+
RMS-I-DE-01	Smoke detector with attached 1.5 m LAN cable (Cat. 5). On/off smoke detector alarm. Can be connected via dry contact when 9 V battery is used.	+	+	+
RMS-I-DE-02	PIR motion detector with attached 1.5 m LAN cable (Cat. 5). Can be connected in a chain of up to 10 Motion Detector Sensors on a single port. 60° detection angle. 3 m detection range.	+	+	+
RMS-I-DE-04	Spot water sensor with 4.5 m cable. Maximum cable extension 60 m.	+	+	+
RMS-I-DE-06	Rope water sensor with 3 m detection cable. 1.5 m LAN communication cable (Cat. 5) included (max. length 30 m). Protects water-sensitive equipment from potential disaster. Detects battery Acid for short-term exposure. Sensor cable can be extended via LAN cable (Cat. 5e/6).	+	+	+
RMS-I-DE-06-EXT3	3 m sensor rope extension for RMS-I-DE-06; maximum extension 50 m	+	+	+
RMS-I-DE-07	Rope water locate sensor with 3 m length detection cable, 6 m non-detection cable and connection cable 1.5 m; (can be extended by LAN cable (Cat. 5e/6)	+	+	+
RMS-I-DE-07-EXT3	3 m rope sensor extension for RMS-I-DE-07; maximum extension 50 m	+	+	+
RMS-I-DRC	Dry contact with 4.5 m cable, input or output; sources up to 20 mA when used as input. Input voltage range 0 to 5 V.	+	+	+
RMS-I-MK	Magnetic door contact with 4.5 m cable (mounting holder included). Maximum extension 300 m. Open/closed contact switch.	+	+	+
RMS-I-PWR-NO	AC-Sensor controlled relay normally open (110 V / 220 V). 1.5 m LAN cable included; maximum length 30 m. Built-in 10A Fuse. C13 and C14 socket connection. Switch can be controlled by any sensor.	+	+	+
RMS-I-VC	4–20 mA Converter with attached 1.5 m LAN cable (Cat. 5). Collects analog values from a wide array of sensors.	+	+	+
RMS-I-CON	RJ45-RJ45 coupler (Cat. 5e) for sensor cable extension, package of 10 pcs	+	+	+
RAMOS ULTRA-EX-D8-8	Expansion board adds 8 dry contacts (IN/OUT) to one intelligent port (RJ45); each can be configured as input or output (sink up to 20 mA). Maximum length of connection cable (LAN Cat. 5/6) 300 m.	+	–	+
RMS-U-DST	Daisy-chain temperature sensor with attached 1.5 m LAN cable (Cat. 5). Up to 8 sensors can be connected to a single intelligent sensor port in 150 m total cable length.	+	–	+
RMS-U-DST-8	Package with 8 pcs of RMS-U-DST	+	–	+
RMS-U-GSM	USB Modem (Quad- band) with audio cable for connection to RAMOS ULTRA	+	–	–*
RMS-U-GSM-3G	USB 3G modem without audio connection	+	–	–*
RMS-U-RB-8	Box with 8 changeover relay contacts for control (manually or via notification)	+	–	+

\*Require GSM variant of RAMOS Plus

## RAMOS MINI ACCESSORIES:

Code	Description	Package
RMS-ST-02	1-wire temperature sensor with 3 m cable; -10 °C to +80 °C	1 pc
RMS-SH-02	1-wire humidity sensor with 3 m cable; 0–100% RH	1 pc
RMS-STH-01	1-wire temperature & humidity sensor with 3 m cable; -30 °C to +80 °C; 0–100% RH	1 pc
RMS-ST-04	Daisy-chain temperature sensor with 3 m cable; -10 °C to +80 °C	1 pc
RMS-STH-02	Daisy-chain temperature and humidity sensor with 3 m cable; -10 °C to +80 °C; 0–100% RH	1 pc
RMS-DE-01	Optical smoke detector*	1 pc
RMS-DE-02	PIR motion detector*	1 pc
RMS-DE-04	Flood detector*	1 pc
RMS-DE-05	Broken glass dual detector*	1 pc
RMS-VS	Vibration sensor	1 pc
RMS-MK-01	Magnetic door contact with fixing bracket and 2.5 m cable	1 pc
RMS-CON-04	Hub for connecting two 1-wire sensors to 1 Wire bus	1 pc
RMS-AS-01	Acoustic siren with LED signaling, 120 dB*	1 pc
RMS-PWR-01	Power Box, remote switching external devices up to 230 V / 10 A, power detection feature	1 pc
RMS-PW-05	Universal power supply 5 V DC	1 pc
RMS-PW-12	EU plug power supply for accessories 12 V DC	1 pc

\*Requires external power supply 12V DC (e.g. RMS-PW-12)



# ACCESS CONTROL SYSTEM (ACS)

➤ Most technical and server rooms face a similar challenge: technical staff require unlimited physical access to servers and other equipment. Each group has different needs, however, meaning individual access rights must be defined; setting up and maintaining these can be difficult and time-consuming.

## RAMOS ULTRA ACS



➤ **RAMOS Ultra ACS** is an expandable monitoring and ACS solution for server rooms and data centers. ACS features require our CONTEG Pro Server for setting up access privileges and users, and comes with all the features of our standard RAMOS Ultra — in which sensors, mapping, smart graphs, intelligent notification or a GSM gateway are required. Equipped with a user friendly web interface for sensor configuration, data collection and extensive graphing.

Code	Description
RAMOS ULTRA ACS	Monitoring device RAMOS Ultra; 2× Intelligent ports (In/Out); 2× expansion ports on front panel; 2× ACS reader ports; 1× ACS door port; 2× ACS Fingerprint reader port; 4× video ports and 4× PTZ ports; Modbus (RS-485); USB 2.0 for connection GSM, Bluetooth or Wi-Fi adapter; power adapter with power cord; 1.5 m crossover patch cord cable; 1U high bracket with screws and installation CD; included lock port converter
RMS-ACS-U-RDU	RAMOS Ultra ACS Expander – Rack Door Unit; controls up to 100 RDU expander units per single RAMOS Ultra; daisy-chain connection up to 25 RDU on single expansion port; 2 intelligent ports for sensors/detectors; power supply with power cord and 1.5 m LAN cable included (requires RAMOS Ultra / Ultra ACS main device and CONTEG Pro Server for setup)

### DESCRIPTION:

- Identical to standard RAMOS Ultra (page 97), except for the following:
  - Monitors with up to 500 intelligent sensors using expansion modules (RAMOS ULTRA-EX-016 and RAMOS ULTRA-EX-18) daisy-chain connected to 2 Expansion ports
  - 2× auto-sense intelligent sensor ports, which can be set to input or output
  - 2× ports for card readers or keypads
  - 1× port for electronic latch or electromagnetic lock
  - 2× USB ports for fingerprint readers
  - 4× USB video ports and 4 PTZ control ports

- Multiple verification options (e.g. fingerprint + PIN + card) can be used for access

#### Rack Door Unit (RDU):

- ACS expander
- Compatible with RAMOS Ultra and RAMOS Ultra ACS
- 1× (green) port for card reader/keypad
- 1× (red) port for electronic latch or electromagnetic lock
- 2× (yellow) auto-sense intelligent sensor ports
- Connected via RJ-45 expansion ports using standard (Cat. 5 LAN cable)

- Can be daisy-chained using E-Out (Silver)/E-In (Blue) ports to other expansion boards
- Maximum length of connection cable (LAN Cat. 5/6) between expander and RAMOS (or between expanders) 300 mm; max. 25 RDU in single expansion line
- 12V DC power supply (included)

### EXAMPLE OF ACCESSORIES

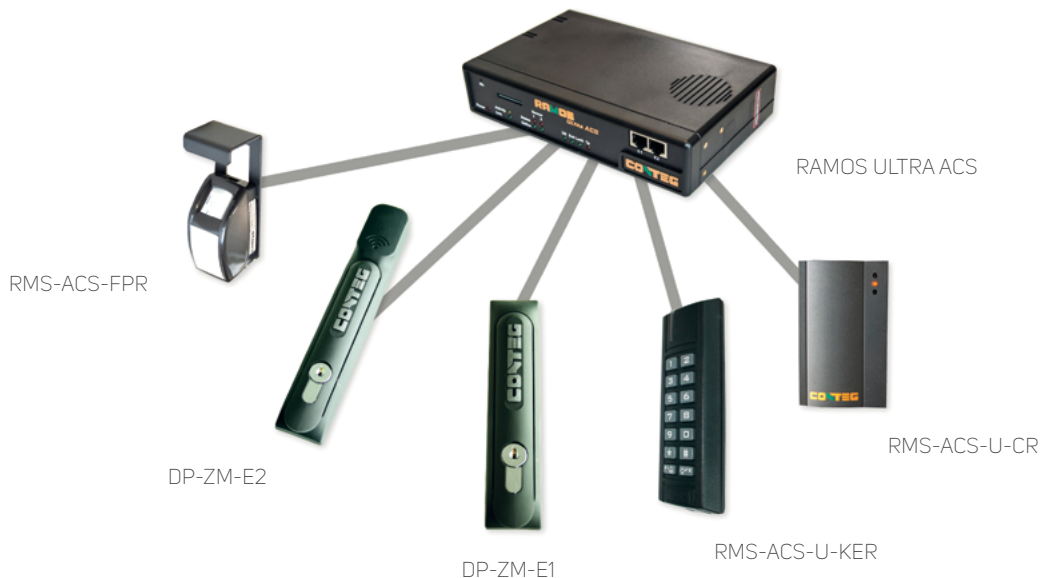

## ACS ACCESSORIES FOR RDU AND RAMOS ULTRA ACS:

Code	Description	Package
RMS-ACS-FPR	Fingerprint reader for RAMOS Ultra ACS unit; includes cable and bracket for mounting	1 pc
RMS-ACS-FPR-D	USB fingerprint reader for PC / Server; includes USB cable	1 pc
RMS-ACS-DCR	USB desktop card reader (EM&HID format 125 kHz with USB cable); suitable for setting access in CONTEG Pro Server	1 pc
RMS-ACS-U-CR	Card reader (EM&HID format 125 kHz) with 4.5 m cable	1 pc
RMS-ACS-U-KER	Keypad with built-in card reader (EM format 125 kHz) with 4.5 m cable	1 pc
DP-ZM-EML-S	Electronic magnetic door lock (Small) with 3 m cable	1 pc
DP-ZM-EML-LW	Electronic magnetic door lock (large – waterproof) with 3 m cable	1 pc
DP-ZM-E1	Electronic door lock with profile half cylinder, 4.5 m cable included	1 pc
DP-ZM-E2	Electronic door lock with profile half cylinder and built-in card reader (EM&HID Prox format 125 kHz), 4.5 m cables included	1 pc
RMS-CON-ACS	Hub for connecting latches to door rack unit (for DP-ZM-E1 and DP-ZM-E2 only)	1 pc

## ACCESS MEDIA:

Code	Description	Package
RMS-ACS-EMT-10	EM Tags, 125 kHz	10 pcs
RMS-ACS-EMT-25	EM Tags, 125 kHz	25 pcs
RMS-ACS-EMC-10	EM Cards, 125 kHz	10 pcs
RMS-ACS-EMC-25	EM Cards, 125 kHz	25 pcs
RMS-ACS-HID-10	HID Prox Cards, 125 kHz	10 pcs
RMS-ACS-HID-25	HID Prox Cards, 125 kHz	25 pcs

## STANDALONE ELECTRONIC LATCHES

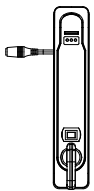

DP-ZM-ES-C

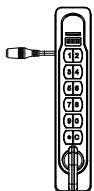

DP-ZM-ES-K

➤ **The Self-Contained Electronic Locking System** features a single component design that can easily be mounted to a standard panel prep, simplifying the integration of electronic access into cabinets while eliminating the need for the wiring or connecting of separate components.

Code	Description	Package
DP-ZM-ES-C	Standalone electronic latch with card reader 13.56 MHz; battery case included, verification via card only	1 pc
DP-ZM-ES-K	Standalone electronic latch with keypad; battery case included, verification by PIN only	1 pc
DP-ZM-ES-PK	Programming key for standalone electronic latch (red)	1 pc
DP-ZM-ES-MK	Manager key for standalone electronic latch (black)	1 pc
DP-ZM-ES-UK	User key for standalone electronic latch (black)	1 pc
RMS-ACS-CMIF	MIFARE® Classic Cards, 13.56 MHz	10 pcs

### DESCRIPTION:

- Unique electrical override feature
- Supports up to 20 RFID cards (RMS-ZM-ES-C) or PINs (RMS-ZM-ES-K)
- Four to seven digit PIN code
- Keyless entry simplifies access control
- Single component design enables easier integration, no wiring
- Operates on three AA batteries (not included)
- Low power operation extends battery replacement interval (50k cycles)
- LED indicator provides visual feedback during programming and operation
- Secure cam lock mechanism
- Fits industry standard 25x150 panel prep
- Programming key offers simple, quick enrollment
- Supports 1 programming key, up to 10 manager keys and up to 10 user keys
- Single point locking mechanism only

# CONTEG PRO SERVER MANAGEMENT SOFTWARE



➤ **CONTEG Pro Server (CPS)** takes the best features of environmental, security monitoring and access control systems and combines them into one centralized management software package.

- MS Windows based software (server and client application)
- User-friendly application supporting most Conteg products
- Min. server/client application hardware requirement specified on Conteg website ([www.conteg.com/conteg-pro-server-management-software](http://www.conteg.com/conteg-pro-server-management-software))

Code	Description
RMS-CPS	Free CPS software for integration with intelligent RAMOS (includes free licenses for 1x IP Camera, 1x virtual sensor, 1x Modbus sensor, 1x CoolTeg Plus, 1x PDU and 1x Template)
RMS-CPS-VS	Adds one virtual sensor to CONTEG Pro Server license
RMS-CPS-MS	Adds one Modbus sensor (via RAMOS Ultra RS-485 port) to CONTEG Pro Server license
RMS-CPS-CTP	Adds one CoolTeg Plus unit (communication via Touch-display) to CONTEG Pro Server license
RMS-CPS-PDU-1U	Adds one Conteg 1U PDU unit (communication via SNMP) to CONTEG Pro Server license
RMS-CPS-PDU-OU	Adds one Conteg OU PDU unit (communication via SNMP) to CONTEG Pro Server license
RMS-CPS-IP-CAM	Adds one third-party IP Camera to CONTEG Pro Server license
RMS-CPS-TMPL	Adds one network device (configured via template) to CONTEG Pro Server license

**DESCRIPTION:**

- Free integration and management of intelligent RAMOS solutions (Plus, Optima, Ultra and Ultra ACS)
- Centralizes RAMOS devices into one application
- Supports direct integration of third-party SNMP and Modbus TCP network devices
- Supports fingerprint access verification (with new RAMOS Ultra ACS)
- Access management – users, groups and history of access
- Monitoring management – sensors, detectors, access and video surveillance
- Customizable mapping feature
- Supports many types of third-party IP cameras and creates event initiation records
- Notification via many types of actions/alarms
- Customizable client access to server (multi-tenant user/group access)
- Can be shown on multiple customizable screens
- Supports basic calculations via virtual sensors (summary & division)



MONITORING-MAPS



MONITORING-GRAPHS

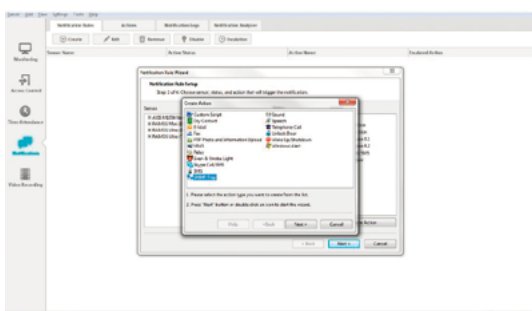

NOTIFICATIONS-ALARMS

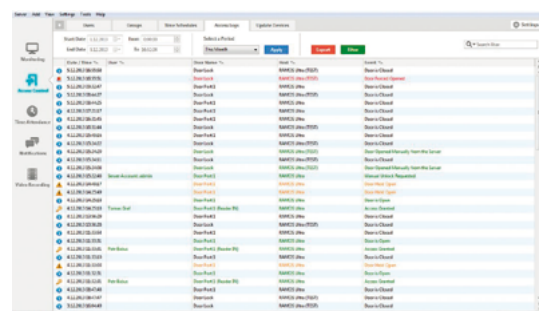

ACS-HISTORY

# AEGIS DCIM



- Conteg has developed the AEGIS DCIM system which collects, analyzes and reports all relevant information using standardized data communication protocols. With DCIM, you have full control of your data center.
- Data centers have changed considerably over the years due to the evolution of information technology, becoming the critical nerve center of today's enterprise. Efficiency has become an important global topic among end-users, policy makers, technology providers and facility architects.
- Contains a real-time performance dashboard, with metrics such as PUE, EUE, EER, etc. Monitors data center status, reporting defects/equipment malfunctions and temperature problems such as excessive humidity. AEGIS also controls strategic equipment, improving PUE.
- PUE (Power Usage Effectiveness), developed by The Green Grid, is a data center metric used to measure overall efficiency. PUE is equal to the total power used by the facility to support the IT load (cooling, UPS and lighting, for example) divided by total IT equipment power consumption. In general, PUE calculations (as opposed to manually gathered information) take place on a monthly basis. Manual calculation is only useful for reporting. If you want to improve data center operation, metrics should be based on real-time information.
- Improving efficiency reduces both your data center's operational expenses (OPEX) and carbon footprint, assuring overall facility compliance with both current and developing governmental regulations. Data center monitoring and control is vital for maintaining maximum availability of your critical operations.

## AEGIS DCIM

Conteg's AEGIS DCIM (Data Center Infrastructure Management) is a complete monitoring application for managing data center infrastructure.

## DATA CENTER EFFICIENCY

Improving efficiency reduces both the data center's operational expenses (OPEX) and carbon footprint. It also helps make the facility compliant with current and future developing governmental regulations.

## INTEGRATION WITH THIRD-PARTY APPLICATIONS

Conteg's AEGIS DCIM is designed to operate with all types of devices, equipment and third-party software applications. Supports communication with such data bases as SAP BAPI (Business

Application Programming Interface), MS SQL server 2008, My SQL, Oracle, MS Access, ODBC, OLEDB and Grid Control (data mining tool enabling OPC and SNMP). Fully customizable, based on the individual needs of each client.

## SCALABLE SOLUTIONS

Conteg's AEGIS Infrastructure Management can be adapted to fit any scenario, meeting data center project requirements regardless of size or scale.

## TECHNICAL INFORMATION

- Metrics such as PUE, EUE, EER, etc. shown on dashboard
- Alarm for defects/equipment malfunctions and temperature problems, such as excessive humidity

- Monitoring and reporting of IT equipment energy consumption – at facility, row, rack or outlet level
- Electrical breaker load monitoring, based on actual and daily peak values
- Capacity reports
- Local and remote accessibility via standard web portal
- Data security on various levels



**For more information**, please contact our sales or technical team: [www.conteg.com/contacts](http://www.conteg.com/contacts)

# KEYBOARD-VIDEO-MOUSE SOLUTIONS (KVM/LCD)

## KVM CONSOLES

➤ **KVM** is a solution for secure access in server farms where simple, universal access is required.



K-SA-171

### DESCRIPTION:

- Designed for deployment in server rooms or data centers, allowing either direct or remote access to individual servers (or their cascades). Console enables server configuration and administration from all main manufacturers (IBM, HP, DELL, SUN and others). Integrated KVM switch, LCD console (including keyboard and touch-pad) housed within a compact (1U high) design.
- Available in two types:
  - Sxxxx - DB15 – direct cable
  - Cxxxx - Cat. 5 – dongle via twisted pair cable



K-SA-171-S1601P-E



K-SA-171-C1601P-E



K-SA-171-S801P-E



K-SA-171-C3201P-E



K-SA-171-CIP3201P-E

KVM SETS – LCD DRAWER & KVM SWITCH			
Code <sup>3</sup>	Number and type of port	Access via IP	Description
K-SA-171-S801P-E	8× USB/PS2 <sup>1</sup>	–	up to 128 servers by 8-level cascade
K-SA-171-S1601P-E	16× USB/PS2 <sup>1</sup>	–	up to 128 servers by 8-level cascade
K-SA-171-C1601P-E	16× Cat 5 <sup>2</sup>	–	up to 256 servers by 8-level cascade
K-SA-171-C3201P-E	32× Cat 5 <sup>2</sup>	–	up to 256 servers by 8-level cascade
K-SA-171-CIP3201P-E	32× Cat 5 <sup>2</sup>	yes	up to 256 servers by 8-level cascade

<sup>1</sup> Includes 8 KVM cables (additional cables to be ordered separately)

<sup>2</sup> USB, PS/2 dongles or Cat. 5 cords required for use (to be ordered separately)

<sup>3</sup> KVM set contains LCD type K-SA-171; can be replaced with any other LCD solution from LCD DRAWERS ONLY table

## LCD HOLDERS

➤ **LCD holders** include high-quality (17" and 19" diagonal) SAMSUNG monitors, allowing the screen to be folded when not in use, so that the total height of the console (including LCD monitor) does not exceed 1U. Includes extrusions designed for both easy assembly and drawing out the KVM/LCD console. Conteg KVM/LCD holders come equipped with a full keyboard (104 keys, including numerical) and optional language localization, including a touchpad.

### DESCRIPTION:

- PS/2 or USB input into the LCD holder (according to the cabling terminal type)
- All LCD drawers include a standard English keyboard; other layouts available on request
- Optional language setting (USA, GBR, JPN, DEU, FRA, ITA, RUS, ESP, CHN, KOR, DNK, CHE, NOR and European localization)
- Equipped with a touchpad (with trackball option)
- Multilingual "on-screen" menu
- Sliding bars with fixed position to prevent movement during typing
- Easy connection to KVM console
- Standard power supply 230 V; 12, 24 and 48 V options available

LCD DRAWERS ONLY										
Code	H (in U)	LCD size	Dimensions (mm)			Dimensions including packing (mm)			Weight (kg)	
			W	D	H	W	D	H	Nett	Gross
K-SA-171	1	17"	442	650	44	589	856	168	16	22
K-SA-191	1	19"	442	650	44	589	856	168	17	23
K-LKD-171	1	17"	442	650	44	589	856	168	15	21

LCD holders can be combined with individual KVM consoles from the Conteg portfolio. Please don't hesitate to contact us if unable to locate the LCD holder or KVM console you desire. Special consoles and holders not included in standard offer.

# LOCAL EXTINGUISHING SYSTEM (LES-RACK)



Information is critically important to us all, therefore data security is paramount. One of the most dangerous threats to our data systems is fire. The LES-RACK ensures that any fires occurring within the rack are dealt with quickly and effectively.

Code	Description
LES-RACK-M	Fire detection, control, evaluation, communication and fire-extinguishing unit
LES-RACK-S	Detection, communication and fire-extinguishing unit

- LES-RACK is a self-contained, fully automatic fire detection and protection system (designed for direct installation into 19" racks with IP30 or higher) offering an efficient, effective solution for servers, telecommunication and control racks/cabinets. The LES-RACK-M unit comes with a fully equipped fire detection, control, evaluation, communication and extinguishing system. Larger-sized server racks and adjacent cabinet units may be protected with additional auxiliary LES-RACK-S units including fire detection, communication and extinguishing systems.
- LES-RACK employs clean gas, flooding the protected space until the fire is completely extinguished. The unit is comprised of metal cylinders filled with agent HFC-236fa Hexafluoropropane, in accordance with TUPO (the Technical Institute of Fire Protection, Authorization Body 221), and pressured by propelling gas.
- Each LES-RACK system is equipped with optical fire detectors, which – in order to eliminate false alarms – are interconnected in double-loop dependency and connected to an evaluation and control unit. This integrated control unit indicates the system's current status, controlling and evaluating the extinguishing unit. The LES RACK-M system allows communication with the building's fire alarm control panel (FACP), reporting the status – pre-alarm, alarm and extinguishing – as the process unfolds.

LES-RACK parameter	Value	LES-RACK parameter	Value
Unit width	483 mm / 19"	Electrical input power	max. 40 VA
Unit height	105 mm / 2.5U	Protection rating	IP30
Unit base depth	382 mm	Shielding class (non-interference)	R02
Total depth of detection extension, according to depth of protected equipment	Max. 750 mm	Supply voltage of main source	230 V ± 15 %
System weight	15.5 kg ± 3 %	Supply frequency of main source	50 Hz
Weight of extinguishing agent	2 kg	Maximum current supplied by main source	1.25 A
Classification of environmental conditions (according to EN 60721-3-3)	3 k5	Standby current	210 mA
Environment class	A	Current consumption during pre-alarm	300 mA
Operating temperature range	-5 °C to 50 °C	Current consumption during alarm	2 A
Relative air humidity	95 % non-condensing	Max. current consumed by outputs in standby	40 mA
Atmospheric pressure	70 to 106 kPa	Max. current consumed by outputs during alarm	0.5 A
Operating position	Horizontal – uppermost position	Max. output voltage on terminal X32 (batt. recharge)	13.7 V
Operation	Permanent	Max. current from terminal X32 (batt. recharge)	200 mA
Operating pressure at 20° C	10 bar	Backup power source (150×94×65 mm)	12 V / 7.2 Ah
Maximum operating pressure	16 bar	Maximum volume of protected cabinet (perforated – min. IP30)	1.5 m <sup>3</sup>
Shielding (according to ČSN EN 55022)	Class-B device	Maximum volume of protected cabinet (closed)	3 m <sup>3</sup>



# INTELLIGENT & BASIC POWER DISTRIBUTION UNITS



MONITORED PDU

➤ The Conteg Intelligent & Basic Power product range comprises three different technologies to address the needs of high-density computing users.

## MAIN ADVANTAGES

- Remotely monitors current draw per strip, using Ethernet and IP (Monitored range)
- Fully manages power strips and groups of power strips across the network (Managed range)
- Offers a combination of outlets, including national outlet styles combined with industrial outlets, high-ampere inputs, and both 1- and 3-phase powered models

## BASIC POWER

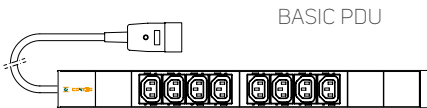

- Designed for standard applications without standard safety or operational requirements (see above). Provide reliable power to cabinet for standard environments.
- Types:
  - a) 19" mounting
  - b) 10" mounting
  - c) Free-standing
  - d) Vertical mounting (OU)
- Outlet types: UTE, SCHUKO, UK, IEC320 C13, IEC320 C19
- Other outlet types (in combination with surge protection and ammeter) also available
- Power output:
  - SCHUKO, UTE, IEC320 C19: 16 A, 250 V
  - UK: 13 A, 250 V
  - IEC320 C13: 10 A, 250 V
- Power input:
  - All types, with 3 m power cord
  - Plug for PDU (UK outlets)
  - Schuko/UTE plug for all other PDUs

### BASIC POWER DISTRIBUTION UNITS – STANDARD ENVIRONMENT

Code	Mounting	H (in U)	Outlet type	Qty	Over voltage protection	Switch
DP-RP-02-UK	10"	1	UK	2	–	–
DP-RP-03-UTE	10"	1	UTE	3	–	–
DP-RP-03-SCHU	10"	1	SCHUKO	3	–	–
DP-RP-06-UTESP*	19"	2	UTE	6	yes	yes
DP-RP-06-SCHUSP*	19"	2	SCHUKO	6	yes	yes
DP-RP-06-UTESP-F	Free	–	UTE	6	yes	yes
DP-RP-06-SCHUSP-F	Free	–	SCHUKO	6	yes	yes
DP-RP-06-UKS	19"	1	UK	6	–	yes
DP-RP-07-UK	19"	1	UK	7	–	–
DP-RP-08-UTES	19"	1	UTE	8	–	yes
DP-RP-08-SCHUS	19"	1	SCHUKO	8	–	yes
DP-RP-09-UTE	19"	1	UTE	9	–	–
DP-RP-09-SCHU	19"	1	SCHUKO	9	–	–
DP-RP-09-IECC19	19"	1	IEC320 C19	9	–	–
DP-RP-12-IECC13	19"	1	IEC320 C13	12	–	–
DP-RP-20-IECC19	Vertical	–	IEC320 C19	20	–	–
DP-RP-20-IECC13	Vertical	–	IEC320 C13	20	–	–
DP-RP-20-SCHUV	Vertical	–	SCHUKO	20	–	–
DP-RP-20-UTEV	Vertical	–	UTE	20	–	–

\* Panels may contain HF filter (models DP-RP-06-UTEPH, DP-RP-06- SCHUPH)



DP-RP-09-UTE



DP-RP-09-SCHU



DP-RP-12-IECC13

Basic Power Distribution Units are designed for high-density, mission-critical server applications. These models provide reliable power to the cabinet for both standard and blade server environments.

BASIC POWER DISTRIBUTION UNITS – STANDARD AND BLADE SERVER ENVIRONMENTS											
Code	Input plug	Length (m)	Type 1 outlet	Qty type 1 outlet	Type 2 outlet	Qty type 2 outlet	Rating (A)	Mounting	Dimensions (mm)		
									H	W	D
IP-BA-308UK8C916	EN 60309	3	UK	8	C19	8	16	OU	860	44	44
IP-BA-312UK8C316	EN 60309	3	UK	12	C13	8	16	OU	985	44	44
IP-BA-308SH8C916	EN 60309	3	SCHUKO	8	C19	8	16	OU	722	44	44
IP-BA-312SH8C316	EN 60309	3	SCHUKO	12	C13	8	16	OU	777	44	44
IP-BA-308UT8C916	EN 60309	3	UTE	8	C19	8	16	OU	780	44	44
IP-BA-312UT8C316	EN 60309	3	UTE	12	C13	8	16	OU	865	44	44
IP-BA-320C34C916	EN 60309	3	C13	20	C19	4	16	OU	908	44	44
IP-BA-320C34C916	C20	3	C13	20	C19	4	16	OU	908	44	44
IP-BA-C08C300010	C14	3	C13	8	None	0	10	1U	439	44	44
IP-BA-C08C300016	C20	3	C13	8	None	0	16	1U	439	44	44
IP-BA-320C34C932	EN 60309	3	C13	20	C19	4	32	OU	1038	44	44
IP-BA-306C900011	EN 60309	3	C19*	6	None	0	3×16	1U	439	44	44
IP-BA-306SH00011	EN 60309	3	SCHUKO	6	None	0	3×16	1U	439	44	44
IP-BA-306UT00011	EN 60309	3	UTE	6	None	0	3×16	1U	439	44	44
IP-BA-306C900022	EN 60309	3	C19*	6	None	0	3×32	1U	439	44	145
IP-BA-318C36C911	EN 60309	3	C13	18	C19	6	3×16	OU	996	44	44
IP-BA-324C36C922	EN 60309	3	C13	24	C19	6	3×32	OU	1673	44	44

\* C19 sockets with lock mechanism (IEC lock)

## INTELLIGENT POWER - MONITORED

- Feature an easy-to-read local ammeter (on the outlet strip), along with the ability to monitor the current draw of outlets remotely over an Ethernet connection. Users can access information from thousands of intelligent Power Distribution Units (PDU) in one location. Designed for high-

density, mission-critical server applications, Conteg Monitored PDUs provide reliable power to the cabinet for both standard and blade server environments.

- Enhanced version offers voltage and frequency metering, enabling reportage of power factor,

active and apparent power and main energy consumed (in kWh). Also calculates carbon emission data (CO<sub>2</sub> footprint) and consumed energy price estimates.



MONITORED PDU

INTELLIGENT POWER DISTRIBUTION UNITS – MONITORED											
Code	Input plug	Length (m)	Type 1 outlet	Qty type 1 outlet	Type 2 outlet	Qty type 2 outlet	Rating (A)	Mounting	Dimensions (mm)		
									H	W	D
IP-DMI-008C300016	C20	x <sup>1</sup>	C13	8	x	x	16	1U	432	44	90
IP-DMI-021C33C916	C20	x <sup>1</sup>	C13	21	C19	3	16	OU	645	44	56
IP-DMI-314C32C932	EN 60309	3	C13	14	C19	2	32	OU	1245	44	56
IP-DMI-321C33C932	EN 60309	3	C13	21	C19	3	32	OU	1645	44	56
IP-DMI-321C33C911	EN 60309	3	C13	21	C19	3	3×16	OU	1778	44	56
IP-DMI-318C36C922	EN 60309	3	C13	18	C19	6	3×32	OU	1778	44	56
INTELLIGENT POWER DISTRIBUTION UNITS – ENHANCED MONITORED (kWh)											
IP-DEI-008C300016	C20	x <sup>1</sup>	C13	8	x	x	16	1U	432	44	90
IP-DEI-321C33C932	EN 60309	3	C13	21	C19	3	32	OU	1645	44	56

<sup>1</sup>INPUT power cords must be ordered separately (see table on page 109)

# INTELLIGENT POWER – MANAGED



MANAGED PDU

- The leading edge in functionality available in a PDU. Employing a server-grade microprocessor, this product has unprecedented management and monitoring capabilities (available through the built in web-server and firewall).
- Individual on/off outlets enable remote reboot of servers
- Virtual grouping of outlets for single-click reboot of multi-corded servers
- Single-click control of entire racks or non-critical loads
- Current monitoring per outlet (POM)
- User-definable sequencing of outlets for reboot
- Designed for high-density, mission-critical server applications, Conteg Managed PDUs provide reliable power to cabinets in both standard and blade-server environments.
- Enhanced version offers voltage and frequency metering, enabling reportage of power factor, active and apparent power and main energy consumed (in kWh). Also calculates carbon emission data (CO<sub>2</sub> footprint) and consumed energy price estimates.

## INTELLIGENT POWER DISTRIBUTION UNITS – MANAGED (MONITORED PER OUTLET)

Code	Input plug	Length (m)	Type 1 outlet	Qty type 1 outlet	Type 2 outlet	Qty type 2 outlet	Rating (A)	Mounting	Dimensions (mm)		
									H	W	D
IP-DMA-008C3POM16 <sup>2</sup>	C20	x <sup>1</sup>	C13	8	x	x	16	1U	432	44	90
IP-DMA-308C9POM32	EN 60309	3	C19	8	x	x	32	1U	432	44	90

## INTELLIGENT POWER DISTRIBUTION UNITS – ENHANCED MONITORED (KWH)

IP-DEA-308C9POM32	EN 60309	3	C19	8	x	x	32	1U	432	44	90
-------------------	----------	---	-----	---	---	---	----	----	-----	----	----

<sup>1</sup> INPUT power cords must be ordered separately (see below)

<sup>2</sup> POM (power outlet monitored); each metered separately

## INTELLIGENT POWER DISTRIBUTION UNITS – MANAGED (MONITORED PER STRIP)

Code	Input plug	Length (m)	Type 1 outlet	Qty type 1 outlet	Type 2 outlet	Qty type 1 outlet	Rating (A)	Mounting	Dimensions (mm)		
									H	W	D
IP-DMA-008C300016	C20	x <sup>1</sup>	C13	8	x	x	16	1U	432	44	90
IP-DMA-021C33C916	C20	x <sup>1</sup>	C13	21	C19	3	16	0U	1778	44	56
IP-DMA-314C32C932	EN 60309	3	C13	14	C19	2	32	0U	1245	44	56
IP-DMA-321C33C932	EN 60309	3	C13	21	C19	3	32	0U	1778	44	56
IP-DMA-318C36C911	EN 60309	3	C13	18	C19	3	3x16	0U	1778	44	56
IP-DMA-318C36C922	EN 60309	3	C13	18	C19	3	3x32	0U	1778	44	56

## INTELLIGENT POWER DISTRIBUTION UNITS – ENHANCED MANAGED (KWH)

IP-DEA-008C300016	C20	x <sup>1</sup>	C13	8	x	x	16	1U	432	44	90
IP-DEA-314C32C932	EN 60309	3	C13	14	C19	2	32	0U	1245	44	56

<sup>1</sup> INPUT power cords must be ordered separately

## Brackets for vertical installation of PDU

Code	Description
DP-RP-VM-01	Brackets for mounting vertical 19" power distribution unit to PREMIUM/OPTIMAL frame
DP-RP-VM-02	Brackets for mounting vertical power distribution unit DP-RP-20-XX to PREMIUM/OPTIMAL frame
DP-RP-VM-06	Swivel brackets for mounting vertical PDU DP-RP-XX and IP-XXX to PREMIUM/OPTIMAL frame, set for 1 PDU
DP-RP-VM-07	Brackets for mounting vertical PDU IP-DXX to RSF and iSEVEN SERVER rack with A-type of extrusions, set for 1 PDU
DP-RP-VM-08	Brackets for mounting vertical PDU IP-BA to RSF and iSEVEN SERVER rack with A-type of extrusions, set for 1 PDU
DP-RP-VM-12	Universal brackets for mounting vertical PDU IP-BA, IP-D or IP-S to rack with L, P and A-type of extrusions, set for 1 PDU

Note: All PDUs are delivered with standard installation brackets. All Basic PDUs have brackets (similar to those used for horizontal installation) that can be rotated 90° at the plastic end caps. Intelligent PDUs have either brackets (for horizontal installation) or flat plates (for vertical attachment) to 19" extrusions.



To find our latest list of products including your ideal intelligent PDU model please visit [www.conteg.com](http://www.conteg.com) or consult with your Conteg Area Sales Manager.

# OUTLET AND PLUG TYPES

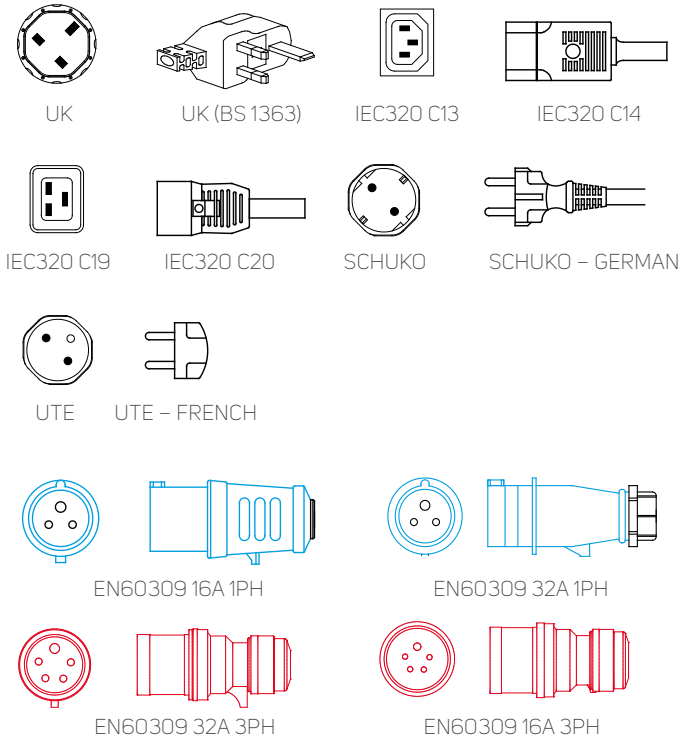

INPUT POWER CORDS FOR INTELLIGENT PDUs		
Code	In-out type	Length
IP-C-C9SH25	IEC 320 C19 to Schuko (plug)	2.5 m
IP-C-C93025	IEC 320 C19 to EN 60309 (1x16 A)	2.5 m
IP-C-C9C225	IEC 320 C19 to IEC 320 C20	2.5 m

Note: Compatible with IP-DMI and IP-DMA

OUTPUT POWER CORDS FOR INTELLIGENT PDUs		
Code	In-out type	Length
IP-C-C9C218	IEC 320 C19 to IEC 320 C20	1.8 m
IP-C-C3C405	IEC 320 C13 to IEC 320 C14	0.5 m
IP-C-C3C410	IEC 320 C13 to IEC 320 C14	1.0 m
IP-C-C3C418	IEC 320 C13 to IEC 320 C14	1.8 m

Note: Compatible with IP-DMI and IP-DMA

LOCKING INSERTS		
Code	Description	Package
IP-C-FC13	Plug Lock sleeve insert for outlet C13	50 pcs
IP-C-FC19	Plug Lock sleeve insert for outlet C19	50 pcs
IP-C-PL20	Plug Lock sleeve insert for C20 input	50 pcs
DP-RP-LC-C3	Locking clips for DP-RP-12-IECC13	12 pcs

## HOW TO READ CODE FOR INTELLIGENT POWER UNITS



An example of a correct Code:

IP - DMI - 3 21 C3 3 C9 11

1. POWER STRIP TECHNOLOGY	
Code	Options
BA	Basic
DMI	Monitored (over IP)
DMA	Managed
DEI	Enhanced Monitored
DEA	Enhanced Managed

2. INPUT PLUG TYPE (on the input power cord)	
Code	Options
0	No cable, Inlet C20 only
C	IEC C20
3	EN 60309

### 3. NUMBER OF OUTLET TYPE 1

4. TYPE OF OUTLET TYPE 1	
Code	Options
UK	UK
SH	Schuko
UT	UTE (French)
C3	C13
C9	C19

### 5. NUMBER OF OUTLET TYPE 2

6. TYPE OF OUTLET TYPE 2	
Code	Options
C3	C13
C9	C19

### 7. STRIP RATING

Code	Options
16	16 Amps
32	32 Amps
11	11 kW (3x16 A)
22	22 kW (3x32 A)

The background features a teal color palette with various technical components. On the left, there are vertical metal brackets with hexagonal bolts. The central and right portions show perforated metal plates, likely part of a server rack or industrial equipment. The overall aesthetic is clean and technical.

06

ACCESSORIES



<b>Shelving</b>	112
19" Fixed Lite Shelves Series DP-PT	112
19" Fixed Shelves Series DP-PO	112
19" Fixed High-Load Shelves Series DP-PZ	112
19" Pull-out Shelves Series DP-PO-V	113
19" Pull-out High Load Shelves Series DP-PZ-V	113
Supporting Rails	113
19" Pull-out Drawer DP-DD	114
19" Pull-out Keyboard Holder Series DP-PV	114
19" Folding Keyboard Holder Series DP-PV	114
21" Adaptors	114
<b>Fiber-optic Products</b>	115
19" Fixed Fiber-Optic Splice Box	115
19" Telescopic Fiber-optic Splice Boxes	116
Wall-Mounting Fiber-optic Splice Boxes	116
<b>Patch Panels</b>	117
19" Panels for 110 Connecting Blocks	117
19" Patch Panels for Keystone Modules	117
19" Patch Panels for LSA-Plus Modules	117
<b>Earthing Bars</b>	118
Cable Clamp Bracket / Earthing Bar for Patch Panel	118
19" Panel with Earthing Bar, Earthing Bar, Earthing Rail	118
<b>Modular Plinths</b>	119
Set of Plinth Corners, Set of Side Panels	119
Plinths for 1200 mm Deep Racks & Space Optimization Sections	120
<b>Mounting &amp; Connecting Kits</b>	121
<b>Others</b>	122
19" Wall-Mounting Holders, Castors & Feet	122
Lighting Units, Cable Protection in Openings	123



# ACCESSORIES

## SHELVING

### 19" FIXED LITE SHELVES SERIES DP-PT

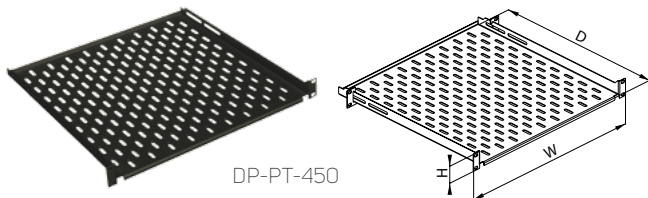

- 1.5 mm sheet steel
- Supporting brackets included
- Color: powder-coated RAL 9005
- Load rating max. 20 kg balanced load; maximum load rating decreased to 25% when mounted on front pair of vertical extrusions only (shelf depth 150, 250, and 350 mm)
- Longer supporting bracket DP-PO-PD available for use
- Package includes: 1x shelf, 2x rear brackets

Code	H (in U)	W	D (mm)	Min-max dist. <sup>1</sup>	Max. dist. <sup>2</sup>	Package
DP-PT-150	1	19"	150	75-121	370	1 pc
DP-PT-250	1	19"	250	125-221	470	1 pc
DP-PT-350	1	19"	350	175-321	570	1 pc
DP-PT-450	1	19"	450	225-421	670	1 pc
DP-PT-550	1	19"	550	275-521	770	1 pc
DP-PT-650	1	19"	650	325-621	870	1 pc
DP-PT-750	1	19"	750	375-721	970	1 pc
DP-PT-850	1	19"	850	425-821	1070	1 pc

<sup>1</sup> Between standard front and rear brackets (in mm)

<sup>2</sup> Between front and rear brackets – with DP-PO-PD (in mm)

### 19" FIXED SHELVES SERIES DP-PO

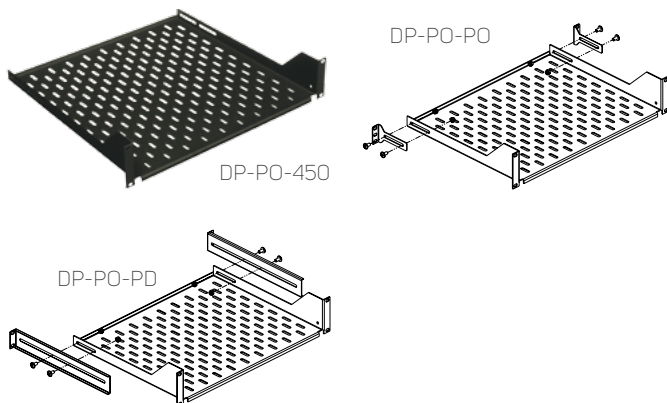

- 2 mm sheet steel
- Support brackets optional
- Color: powder-coated RAL 9005
- Load rating max. 60 kg balanced load (when supporting brackets used – ordered separately); load rating decreased to 25% when mounted on front pair of vertical extrusions only – shelf depth 150, 250 and 350 mm
- Package includes:
  - DP-PO-xxx: 1x shelf

Code	H (in U)	W	D (mm)	Min-max dist. <sup>1</sup>	Max. dist. <sup>2</sup>	Package
DP-PO-150	1	19"	150	75-180	385	1 pc
DP-PO-250	1	19"	250	125-265	470	1 pc
DP-PO-350	2	19"	350	230-380	585	1 pc
DP-PO-450	2	19"	450	260-480	685	1 pc
DP-PO-550	2	19"	550	360-580	785	1 pc
DP-PO-650	2	19"	650	460-680	885	1 pc
DP-PO-750	2	19"	750	560-780	985	1 pc
DP-PO-850	2	19"	850	660-880	1085	1 pc

<sup>1</sup> Between standard front and rear brackets (in mm)

<sup>2</sup> Between front and rear brackets – with DP-PO-PD (in mm)

#### SUPPORTING BRACKETS

Code	Type	Packing	Length (mm)	H (in U)
DP-PO-PO	Standard	1 pair	88	1
DP-PO-PD*	Extended	1 pair	298	1

\* Compatible with DP-PO-xxx, DP-PT-xxx

### 19" FIXED HIGH-LOAD SHELVES SERIES DP-PZ

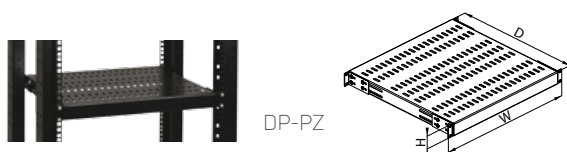

- 2 mm sheet steel, reinforced with metal bars
- Four supporting brackets (for mounting on vertical extrusions) included
- Color: powder-coated RAL 9005
- Load rating max. 100 kg balanced load
- Package includes: 1x shelf, 4x brackets, 16x screws M6, 16x nuts M6

Code	H (in U)	W	D (mm)	Min-max distance <sup>1</sup>	Package
DP-PZ-450	1	19"	450	113-463	1 pc
DP-PZ-550	1	19"	550	213-563	1 pc
DP-PZ-650	1	19"	650	313-663	1 pc
DP-PZ-750	1	19"	750	413-763	1 pc
DP-PZ-850	1	19"	850	513-863	1 pc

<sup>1</sup> Between standard front and rear brackets (in mm)

## 19" PULL-OUT SHELVES SERIES DP-PO-V

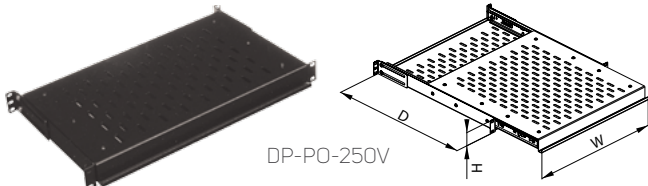

DP-PO-250V

- 1.5 mm sheet steel
- Height: 1U
- Equipped with one pair of side telescopic rails
- Supporting brackets included
- Color: powder-coated RAL 9005
- Load rating max. 25 kg balanced load; maximum load rating decreased to 25% when mounted on front pair of vertical extrusions only (shelf depth: 250 and 350 mm)
- Package includes: 1x shelf, 2x rear brackets, 4x screws M5

Code	H (in U)	W	D (mm)	Min-max dist. <sup>1</sup>	Drawout part max.	Package
DP-PO-250V	1	19"	271	155-370	160 mm	1 pc
DP-PO-350V	1	19"	371	255-470	260 mm	1 pc
DP-PO-450V	1	19"	471	355-570	325 mm	1 pc
DP-PO-550V	1	19"	571	455-670	410 mm	1 pc
DP-PO-650V	1	19"	671	555-770	485 mm	1 pc
DP-PO-750V	1	19"	771	655-870	520 mm	1 pc

<sup>1</sup> Between standard front and rear brackets (in mm)

## 19" PULL-OUT HIGH LOAD SHELVES SERIES DP-PZ-V

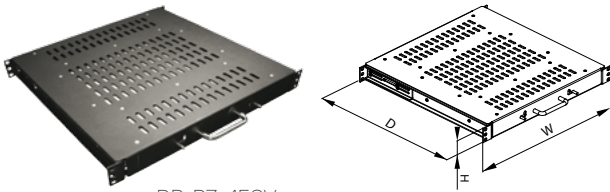

DP-PZ-450V

- 2 mm and 2.5 mm sheet steel
- Height: 1U
- Max. pull-out 450 mm
- Color: powder-coated RAL 9005
- Load rating max. 80 kg balanced load
- Package includes: 1x shelf

Code	H (in U)	W	D (mm)	Min-max distance <sup>1</sup>	Package
DP-PZ-450V	1	19"	471	296-507	1 pc
DP-PZ-550V	1	19"	571	406-607	1 pc

<sup>1</sup> Between standard front and rear brackets (in mm)

## SUPPORTING RAILS

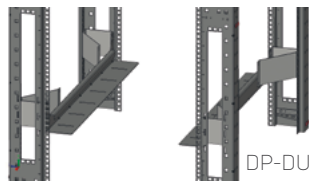

DP-DU-75S-800

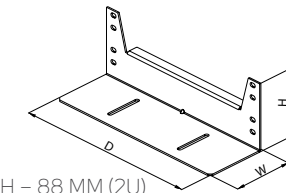

DP-DU

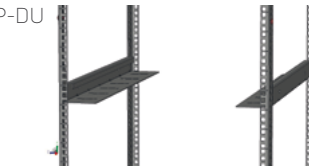

DP-DU-75S-600

H - 88 MM (2U)  
W - 80 MM

- 2 mm sheet steel
- Mountable on vertical extrusion side holes (with DP-MO-01 mountain kit, not included)
- Color: powder-coated RAL 9005
- Space between rails provides effective cooling of active devices
- Load rating max. 50 kg balanced load
- Package includes:
  - DP-DU-xxxx: 2x supporting rails
  - DP-DU-S75: 2x supporting rails, 4x brackets for 800 mm racks, 36x screws M5, 16x floating nuts M5
- Compatible with L-Type extrusions; other information upon request

Rack	Max. DP-DU
RDF 80/80	700
RDF 80/100	900
RSF 60/80	700
RSF 60/100	900
RSF 80/80	700
RSF 80/100	900
Rx7 60/60	500
Rx7 60/80	700
Rx7 60/100	900
Rx7 80/80	700
Rx7 80/100	900

Replace x with i or M

SUPPORTING RAILS			
Code	Distance between front and rear vertical L-type extrusions (mm)	Depth (mm)	Package
DP-DU-300	296	242	1 pair
DP-DU-400	396	342	1 pair
DP-DU-500	496	442	1 pair
DP-DU-600	596	542	1 pair
DP-DU-700	696	642	1 pair
DP-DU-800	796	742	1 pair
DP-DU-900	896	842	1 pair
DP-DU-1000	996	942	1 pair
DP-DU-S75 *	740	692	1 pair

\* Load rating of 100 kg for 600 and 800 mm width

## 19" PULL-OUT DRAWER DP-DD

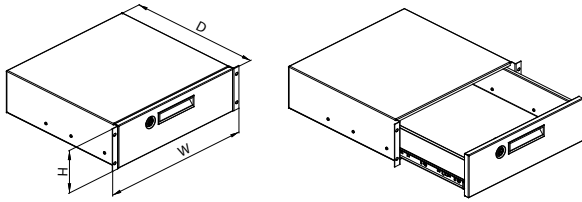

- 1.25 and 1.5 mm sheet steel
- Height: 3U
- Max. pull-out distance 280 mm
- Color: powder-coated RAL 9005
- Load rating max. 10 kg balanced load
- Package includes: 1x drawer

Code	H (in U)	W	D (mm)	Package
DP-DD-03	3	19"	430	1 pc

## 19" PULL-OUT KEYBOARD HOLDER SERIES DP-PV

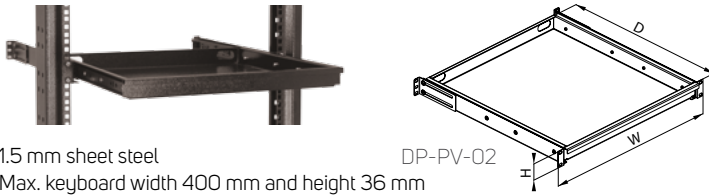

- 1.5 mm sheet steel
- Max. keyboard width 400 mm and height 36 mm
- Shelf depth: 480 mm
- Max. pull-out distance 330 mm
- Color: powder-coated RAL 9005
- Supporting brackets included
- Supporting brackets DP-PV-PD for installation into 800 and 1000 mm deep racks (optional)
- Package includes: 1x keyboard holder, 2x rear brackets, 4x screws M5, 1x self-adhesive velcro tape

Code	H (in U)	W	D (mm)	Package
DP-PV-02	1	19"	480	1 pc

## 19" FOLDING KEYBOARD HOLDER SERIES DP-PV

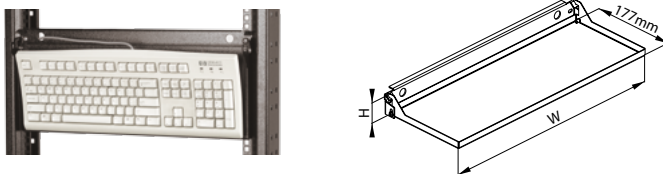

- Enables keyboard placement in front of sliding vertical extrusions
- Max. keyboard size 480x175 mm
- Color: powder-coated RAL 9005
- Height: 1U
- Fix keyboard to shelf using self-adhesive velcro – 8 pcs of size 12x25 mm (included)
- Package includes: 1x keyboard holder, 1x self-adhesive velcro tape

Code	H (in U)	W	Package
DP-PV-01	1	19"	1 pc

## 21" ADAPTORS

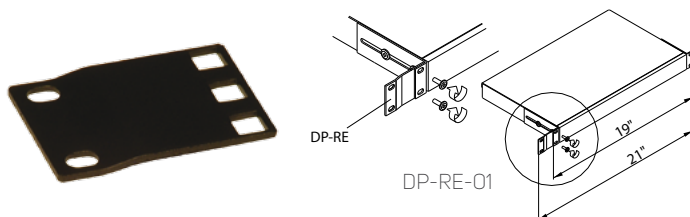

- Allows for use of 19" equipment in 21" rack
- Color: powder-coated RAL 9005
- Package includes: 1x adaptor

Code	H (in U)	Package
DP-RE-01	1	1 pc
DP-RE-02	2	1 pc
DP-RE-03	3	1 pc

# FIBER-OPTIC PRODUCTS

## 19" FIXED FIBER-OPTIC SPLICE BOX

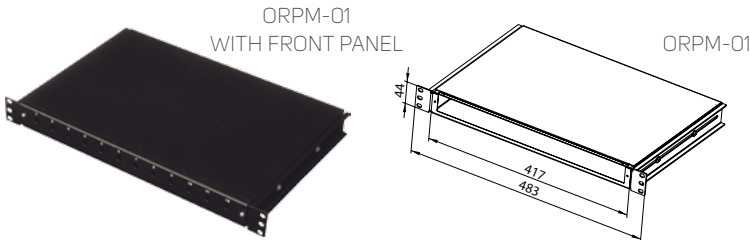

- Type: fixed
- Height: 1U
- Modular front panels not included (see below)
- Up to 24 positions for FO couplings
- Front panel must be selected and ordered separately
- Cable entry openings in rear

- Holes not in use can be covered with blank modules
- Installed in racks with adjustable holders
- Installation kit for splice cassettes and inner organizer (included)
- Wide range of accessories (optional)
- Color: powder-coated RAL 9005

- Package includes:
  - ORPM-01: 1x fibre-optic box, 2x cable holders, 2x 19" brackets, 4x screws M5, 2x screws M4
  - OR-xxxx: 1x front panel

Code	H (in U)	W	D (mm)	Description	Package
ORPM-01	1	19"	300	Fixed	1 pc



ACCESSORIES FOR FIBER-OPTIC SPLICE BOXES		
Code	Description	Package
ORO-K2000	Splice cassette	1 pc
ORO-PG11	PG11 coupling	10 pcs
ORO-PG16	PG16 coupling	10 pcs
ORO-ZPG11	Cover of opening for PG11 coupling	10 pcs
ORO-ZPG16	Cover of opening for PG16 coupling	10 pcs
ORO-01	Front organizer for ORPM	1 pc
ORO-02	Front organizer for ORVM	1 pc
ORO-03	Rear organizer	1 pc

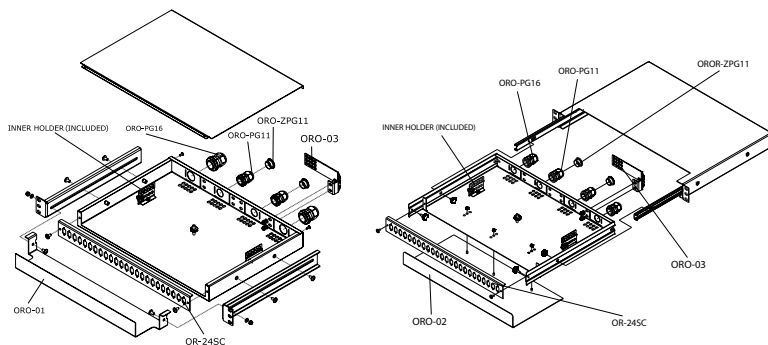

TYPES OF MODULAR FRONT PANELS					
Code	Number of holes for FO couplings				Package
	8	12	16	24	
OR-xxST	yes	yes	yes	yes	1 pc
OR-xxSC	yes	yes	yes	yes	1 pc
OR-xxDSC	yes	yes	yes	yes*	1 pc
OR-xxFC	yes	yes	yes	yes	1 pc
OR-xxFCD	yes	yes	yes	yes	1 pc

\* Without numbering and holes for screws

Note: All dimensions in mm

## 19" TELESCOPIC FIBER-OPTIC SPLICE BOXES



ORVE-01-250

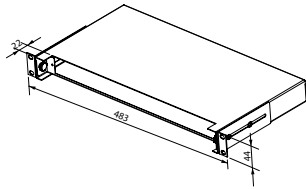

Code	H (in U)	W	D (mm)	Description	Package
ORVM-01	1	19"	320	Telescopic	1 pc
ORVE-01-250	1	19"	250	Telescopic	1 pc

- Used to terminate optical cables in racks
- Type: telescopic
- Height: 1U
- Modular front panels not included – see table on page 115
- Up to 24 positions for FO couplings
- Front panel must be selected and ordered separately

- Cable entry openings in rear
- Holes not in use can be covered with blank modules
- Installs into racks with two sliding holders
- Installation kit for splice cassettes and inner organizer included (ORVM-01 only)
- Wide range of accessories (optional)
- Color: powder-coated RAL 9005

- Package includes:
  - ORVM-01: 1x fibre-optic box, 2x cable holders, 2x screws M4
  - ORVE-01-250: 1x fibre-optic box, 2x 19" brackets, 6x screws M4

## WALL-MOUNTING FIBER-OPTIC SPLICE BOXES

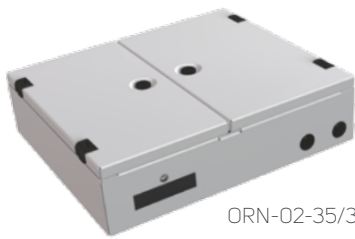

ORN-02-35/30

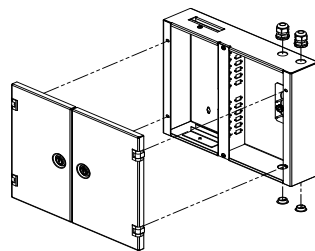

ORN-01

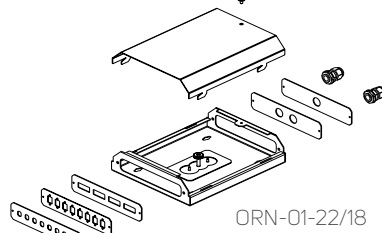

ORN-01-22/18

Code	Type	W x H (mm)	Package
ORN-01-30/18	Single	300x180	1 pc
ORN-01-22/18	Single	220x180	1 pc
ORN-02-35/30	Double	350x300	1 pc

PANELS FOR WALL-MOUNTING FIBER-OPTIC SPLICE BOXES		
ORN-01-30/18 and ORN-01-22/18	ORN-02-35/30	Package
ORN-M-8ST	ORN-24ST	1 pc
ORN-M-8SC	ORN-24SC	1 pc
ORN-M-4DSC	ORN-12DSC	1 pc
ORN-M-1PG	ORN-24FC	1 pc
ORN-M-2PG	ORN-12FCD	1 pc
ORN-M-8FC	-	1 pc
ORN-M-4FCD	-	1 pc

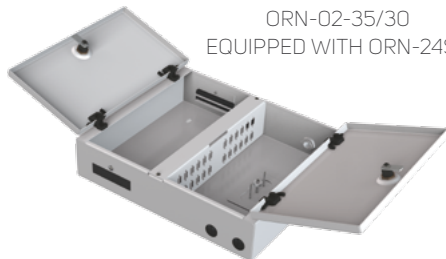

ORN-02-35/30  
EQUIPPED WITH ORN-24SC



ORN-01-30/18

- Wall-mounting fiber-optic splice boxes (used to terminate optical cables)
- Types:
  - double – size 350x300 mm; equipped with double-leaf door and lock
  - single – size 300x180 mm or 220x180 mm
- Modular panels with holes for couplings – see table below (must be ordered separately)
- In double FO splice-box up to 24 positions for ST or SC or FC or 12 DSC or FCD adapters

- In single FO splice-box up to 8 positions for ST or SC or FC or 4 DSC or FCD adapters
- Holes not in use can be covered with blank modules
- Cable entry through PG couplings (PG 9 for ORN-01 and PG 11 for ORN-02)
- Installation kit for splice cassette (ORO-K2000) included
- Color: powder-coated RAL 7035

- Package includes:
  - ORN-01-xx/xx: 1x WM box (box with cover), 1x screw M4, 4x screws M3, 1x nut M5
  - ORN-02-xx/xx: 1x WM box (box with 2 doors), 2x PG11 with nuts, 2x Cover of opening for PG, 2x screws M4, 1x nut M5
  - ORN-M-xxxx, ORN-xxxxx: 1x panel

### TYPES OF HOLES FOR FIBER-OPTIC CONNECTORS:

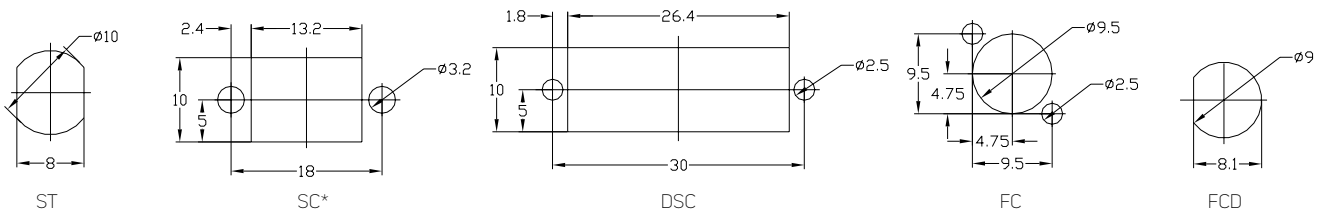

\* Used also for DUAL-LC (adapter needed)

Note: Dimensions in mm (before powder coating)

# PATCH PANELS

## 19" PANELS FOR 110 CONNECTING BLOCKS

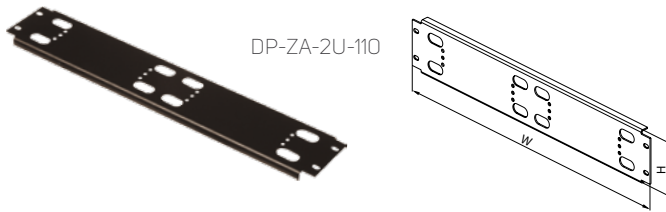

- For installation of 110 connecting blocks in 19" racks
- Available in 2U and 4U
- Color: powder-coated RAL 9005
- Can install up to 100 pairs for 2U height (incl. wire management)
- Package includes panels for 100 blocks

Code	H (in U)	For		Package
		110 block	Cable man. panel	
DP-ZA-2U-110	2	1 pc	1 pc	5 pcs
DP-ZA-4U-110	4	2 pcs	2 pcs	5 pcs

## 19" PATCH PANELS FOR KEYSTONE MODULES

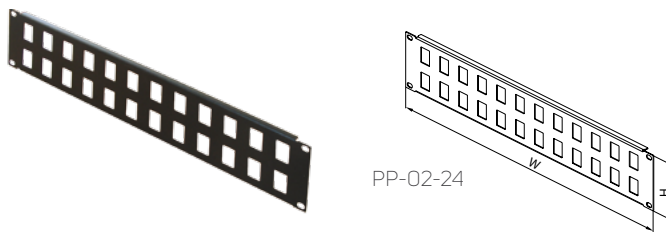

- For installation of Keystone rack modules
- Available in heights of 1U, 2U and 3U
- Can install up to 16 Keystone modules for 1U height (hole size 16.7x24.3 mm)
- Color: powder-coated RAL 9005
- Each module requires DP-KEY adaptor
- Package includes: 1x panel for Keystones

Code	H (in U)	Width	No. of positions	Package
PP-01-16	1	19"	16	1 pc
PP-02-24	2	19"	24	1 pc
PP-02-32	2	19"	32	1 pc
PP-03-48	3	19"	48	1 pc

## 19" PATCH PANELS FOR LSA-PLUS MODULES

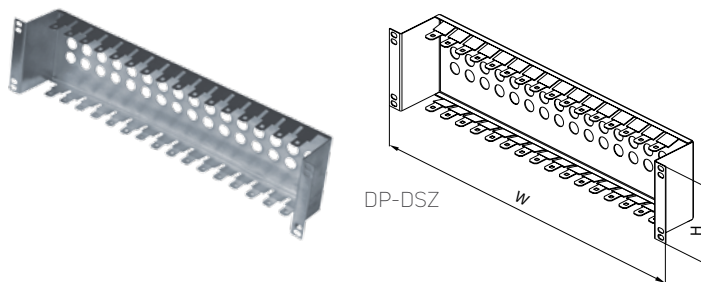

- For installation of LSA-PLUS modules (96 mm spacing)
- 16 positions for 10 pairs of LSA-PLUS modules
- Zinc-plated finish
- Package includes: 1x panel for LSA-PLUS modules

Code	H (in U)	Width	No. of positions	Package
DP-DSZ	2.5	19"	16	1 pc



# EARTHING BARS

## CABLE CLAMP BRACKET / EARTHING BAR FOR PATCH PANEL

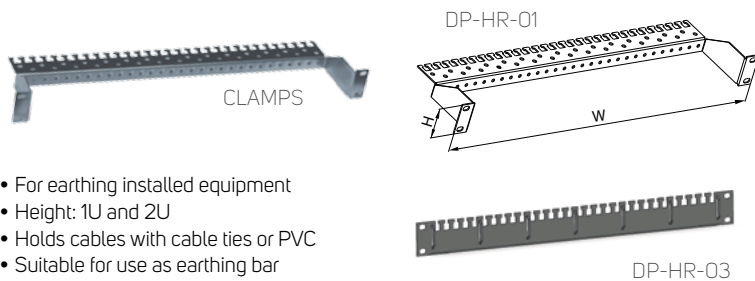

- For earthing installed equipment
- Height: 1U and 2U
- Holds cables with cable ties or PVC
- Suitable for use as earthing bar
- Zinc-plated finish
- Package includes:
  - DP-HR-01, DP-HR-02: 1x earthing bar
  - DP-HR-03: 5x earthing bar, 5x mounting kit DP-MO-01

Code	Description	Package
DP-HR-01	19" cable clamp bracket / earthing bar for patch panel, 1U	1 pc
DP-HR-02	19" cable clamp bracket / earthing bar for patch panel, 2U	1 pc
DP-HR-03	19" cable clamp bracket / earthing bar cable / bundle of cables, 1U	1 set

## 19" PANEL WITH EARTHING BAR

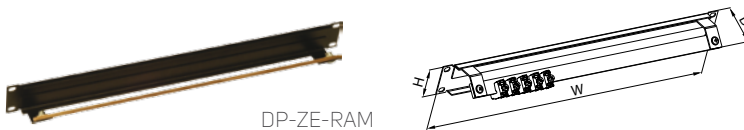

- Height: 1U
- Copper earthing rail with 5 earthing clips (DP-ZE-CL) included
- Color: powder-coated RAL 9005
- Package includes:
  - DP-ZE-RAM: 1x earthing rail, 5x clips DP-ZM-CL
  - DP-ZE-CL: 1x earthing clip

Code	Description	Package
DP-ZE-RAM	19" panel with earthing rail and 5 clips	1 pc
DP-ZE-CL	Earthing clip	1 pc

## EARTHING BAR

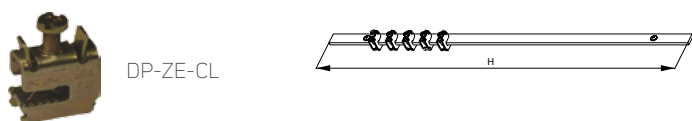

- For rack sizes 15–48U
- 25x5 mm copper bar
- Installation kit for rack mounting (included)
- Package includes: 1x earthing bar, 5x clips DP-ZM-CL, 4x screws M5, 4x nuts M5

Code	H (in U)	Length (mm)	Package
DP-UL-15U	15	667	1 pc
DP-UL-21U	21	933	1 pc
DP-UL-27U	27	1200	1 pc
DP-UL-33U	33	1467	1 pc
DP-UL-42U	42	1867	1 pc
DP-UL-45U	45	2000	1 pc
DP-UL-48U	48	2134	1 pc

## EARTHING RAIL



- 22 terminals for cable diameters:
  - ø 1–10 mm<sup>2</sup> – solid conductor
  - ø 1–6 mm<sup>2</sup> – stranded conductor
- Nominal voltage – 230/400 V
- Nominal current – 40 A
- Mounting kit for installation (at either frame or extrusions)
- Ground cable 6 mm<sup>2</sup> with M8 lug, length 500 mm
- In accordance with standard specification LG-19
- Package includes: 1x earthing rail, 2x plastic holders, 2x screws M5

Code	Description	Package
DP-ZE-ER24	Earthing rail, 8x8 mm, 22 terminals, 40 A, ground cable	1 pc

# MODULAR PLINTHS



➤ **Plinths** are installed as both an aesthetic and stabilizing element instead of feet or castors. When a filter is used, the plinth supplies a sufficient amount of filtered air. Can also be used for storing cables.

- Used with PREMIUM and iSEVEN rack series (RDF, RSF, RSB, RI7 and RM7)
- Height: 100 mm
- Color: powder-coated RAL (standard RAL 7035 or 9005)
- Delivered unassembled; assembly hardware and instructions included
- Consists of:
  - Set of corners
  - Set of side panels

## SET OF PLINTH CORNERS

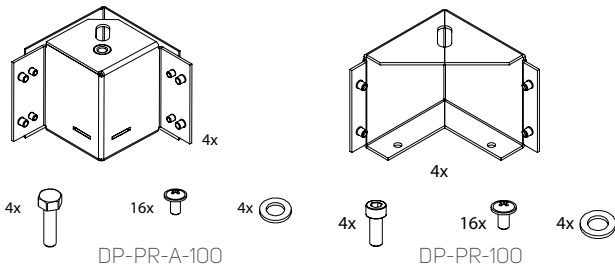

- Used for all types of free-standing racks
- Available in three types:
  - a) DP-PR-100: fixed height 100 mm; for total load (IT equipment + rack) up to 800 kg (also applicable for racks 1 200 mm deep, with load rating up to 1000 kg)
  - b) DP-PR-HL-100: fixed height 100 mm for total load (IT equipment + rack) 800 kg and more
  - c) DP-PR-A-100: fixed height 100 mm, equipped with adjustable feet; for total load (IT equipment + rack) up to 1700 kg
- Package includes: 4x plinth corners, 4x screws M10, 16x screws M5

Code	Load rating (kg)*	Package
DP-PR-100	800	1 set of 4 pcs
DP-PR-A-100	1700	1 set of 4 pcs
DP-PR-HL-100	1700	1 set of 4 pcs

\* Load rating for set (4 pcs) of corners, incl. weight of rack

## SET OF SIDE PANELS

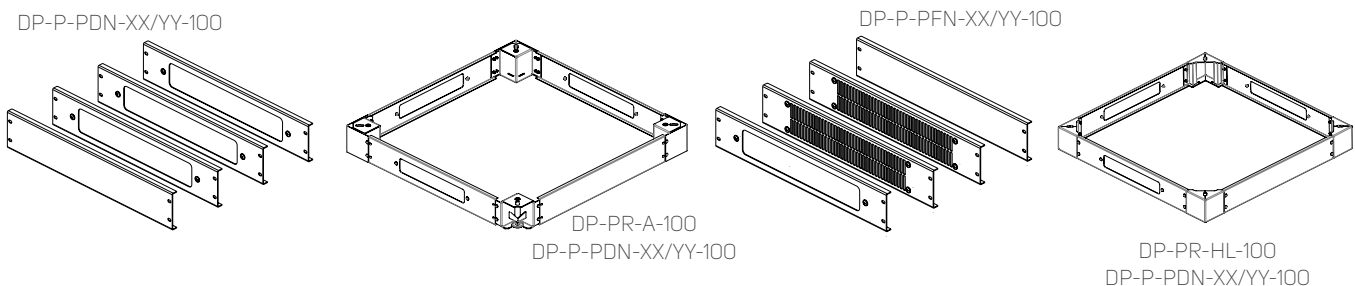

- Available in two types:
  - a) With cable entry openings (in DP-P-PDN-xx/yy)
  - b) With perforation and exchangeable filters (in DP-P-PFN-xx/yy)
- Package includes: 1x plinth panel full, 3x plinth panels with cable entry or perforations

## FOLLOW THE STEPS TO SET UP THE DESIRED CODE!

### PLINTH CORNERS

**DP - PR - 1. - 100**

An example of a correct Code:

**DP - PR - HL - 100**

### SIDE PANELS

**DP - P - 1. - 2. / 3. - 100**

An example of a correct Code:

**DP - P - PDN - 600 / 600 - 100**

1.	
Code	Options
HL	Plinth corners – high load
A	Plinth corners with adjustable feet

1.	
Code	Options
PDN	Plinth without filter
PFN	Plinth with filter

2.
Options
Rack width (mm) – ie. 600, 800

3.
Options
Rack depth (mm) – ie. 600, 800, 1000

Ordering code for exchangeable filter:  
 DP-P-PFN-FI-600 – 600 mm length  
 DP-P-PFN-FI-800 – 800 mm length

## PLINTHS FOR 1200 MM DEEP RACKS & SPACE OPTIMIZATION SECTIONS

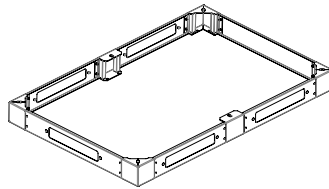
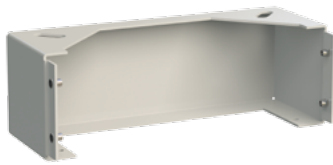

DP-P-PDN-100-80/120  
 DP-PR-HL-100

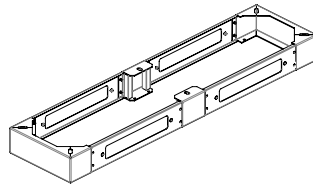

DP-PDN-30/YYY-100

Code	Description	Package
DP-P-PDN-100-60/120 *	Set of plinth panels for 60/120 (height 100 mm)	1 set
DP-P-PDN-100-80/120 *	Set of plinth panels for 80/120 (height 100 mm)	1 set

\* With DP-PR -100 (height 100 mm)

Code	Description	Package
DP-PDN-30/60-100	Plinth for space optimization section 30/60, height 100 mm	1 set
DP-PDN-30/80-100	Plinth for space optimization section 30/80, height 100 mm	1 set
DP-PDN-30/100-100	Plinth for space optimization section, 30/100, height 100 mm	1 set
DP-PDN-30/120-100	Plinth for space optimization section, 30/120, height 100 mm	1 set

- Set of plinth panels for rack footprint xx/yyy (height 100 mm)
- Package includes:
  - DP-P-PDN-100-xx/120: 6x panels, 2x middle plinths
  - DP-PDN-30/xx-100: 2x panel set, 2x plinth

# MOUNTING & CONNECTING KITS

## MOUNTING KIT



DP-MO-01



DP-MO-F2

- Attaches equipment to vertical extrusions
- Package includes:
  - DP-MO-0x: 1x screw, 1x floating nut, 1x washer
  - DP-MO-F2: 1x screw, 1x nut
  - DP-MO-100: 100x mounting kit (1x screw, 1x floating nut, 1x washer)

Code	Description	Size	Package
DP-MO-01 <sup>1</sup>	Mounting kit	M5	1 set
DP-MO-02 <sup>1</sup>	Mounting kit	M6	1 set
DP-MO-F2 <sup>1</sup>	Mounting kit – fast installation	M6	1 set
DP-MO-100	Mounting kit – multipack	M5	1 set

<sup>1</sup>Please order in multiples of four only (one package = 4 sets, see above)

## CONNECTING KITS



DP-DR-UNI



DP-DR-UNI-Q



DP-DR-7

- Connects (bays) free-standing racks of the same height and depth into one row; The DP-DR-UNI connects entire rack series
- DP-DR-UNI-Q: QUICK connecting (QC) kit is used to connect entire free-standing rack series; one-man installation ready, tool-less version

- DP-DR-UNI: connects entire rack series; side panels need not be removed
- DP-DR-7: connects entire rack series; side panels must be removed

- Package includes:
  - DP-DR-UNI-Q: 3x QC brackets, 3x butterfly screws M5x16, 6x screws M5x16, 3x nuts M5
  - DP-DR-UNI: 6x butterfly nuts M5, 6x screws M5x20, 12x washers
  - DP-DR-7: 6x hexagonal nuts, 12x screws M5x10, 12x washers M5 DIN125

Code	Description	Package
DP-DR-UNI-Q	QUICK connecting kit for all free-standing rack series; tool-less	1 set
DP-DR-UNI	Connecting kit for all free-standing rack series	1 set
DP-DR-7	Connecting kit for rack series	1 set

# ACCESSORIES

## OTHERS

### 19" WALL-MOUNTING HOLDERS

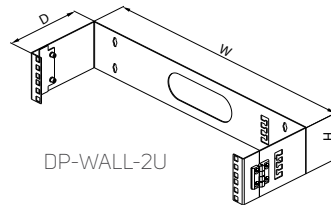
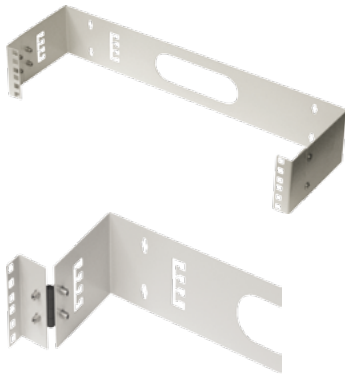

Code	H (in U)	W	Depth (mm)	Package
DP-WALL-2U	2	19"	150	1 pc
DP-WALL-4U	4	19"	150	1 pc

- For 19" wall equipment installation
- 2U and 4U in height
- Mounting holes (for wall installation) on rear
- Holder equipped with hinges (enables equipment to swing open from wall)
- Side cable entry openings
- Color: powder-coated RAL 7035
- Package includes: 1x Wall-mounting holder

### CASTORS & FEET



DP-KO-H1



DP-KO-H2



DP-KO-02



DP-KO-01



DP-KO-TC



DP-NO-01

Code	Description	Load rating per castor (kg)*	Package
DP-KO-01	Castor for free-standing cabinet	50 kg	1 pc of set 1
DP-KO-02	Lockable castor for free-standing cabinet	50 kg	1 pc of set 1
DP-KO-H1	High-load castor for free-standing cabinet	100 kg	1 pc of set 1
DP-KO-H2	Lockable high-load castor for free-standing cabinet	100 kg	1 pc of set 1
DP-NO-01	Adjustable foot for free-standing cabinet	-	1 pc of set 2
DP-KO-TC	Transport castors for free-standing racks	30 kg	1 pc of set 3

\* Castor load rating = (rack weight + device weight) / 3

- Package includes:
  - Set 1: 1x castor, 1x screw M10, 1x washer
  - Set 2: 1x foot
  - Set 3: 4x castors

## LIGHTING UNITS



DP-OJ-05



DP-OJ-01



DP-OJ-04

- Illuminates rack
- DP-OJ-01 and DP-OJ-05 ready for 19" installation
- DP-OJ-04 and DP-OJ-05 can be magnetically fixed into place on any sheet steel part in/on rack (OU installation)
- Automatic function ensured by motion sensor (DP-OJ-05 only)
- Package includes:
  - DP-OJ-01: 1x 19" light unit, 1x power cord
  - DP-OJ-04: 1x light unit (magnetic), 1x power cord
  - DP-OJ-05: 1x light unit (magnetic), 1x 19" holder, 2x screws M5, 1x power cord

Code	Description	Package
DP-OJ-01	Lighting unit – telescopic, 19" installation, florescent tube 230 V/50 Hz with switch	1 pc
DP-OJ-04	Lighting unit, 5 W, LED technology, magnets for easy fixing	1 pc
DP-OJ-05	Lighting unit, 11 W, motion sensor, magnets for easy fixing or 19" installation	1 pc

## CABLE PROTECTION IN OPENINGS

DP-KP-KAR



DP-KP-HCE2



DP-KP-RB4



DP-KP-KAR9

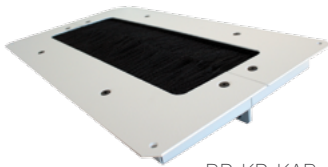
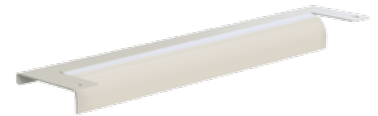

DP-KP-KAR-A



DP-KP-KAR7



DP-KP-KAR4



DP-KP-KAR4-D

- Protective strips and brush panels help protect cable entries, limiting dust penetration
- Installed in cable entry openings (300x100 mm or 300x50 mm)
- Mounting holes (for wall installation) on rear

Code	Description	Available colors		Package
		RAL 7035	RAL 9005	
DP-KP-LEM	Protective edging of cable entries (length 790 mm)	–	yes	1 pc
DP-KP-HCE2	Hermetic cable entry for rack with IP54 (opening 300x100 mm)	yes	yes	1 pc
DP-KP-KAR	Cable entry covered with brush for iSEVEN and Premium series (opening 300x100 mm)	yes	yes	1 pc
DP-KP-KAR3	Cable entry 150x56 mm covered with brush for RUN, RUD, REN series	yes	–	1 pc
DP-KP-KAR4	Cable entry, two layers of brushes (opening 300x100 mm)	yes	yes	1 pc
DP-KP-KAR4-D	Cable entry, two layers of brushes, divided version (opening 300x100 mm)	yes	yes	1 pc
DP-KP-KAR5	Cable entry 300x50 mm, covered with brush	yes	yes	1 pc
DP-KP-KAR6	Dust-proof brush for cable entry 500x110 mm (for RI7/RM7), two pieces of brushes and two pieces of rubber for edges of cable entry	–	yes	1 pc
DP-KP-KAR7	Slidable cover for cable entry 300x100 mm	yes	yes	1 pc
DP-KP-KAR9	Cable entry with radius cable protection, for 300x100 mm opening	yes	yes	1 pc
DP-KP-RB4	Cable entry diameter 100 mm (4"), covered with brush	–	yes	1 pc
DP-KP-RP4	Cable entry diameter 100 mm (4"), plastic	–	yes	1 pc
DP-KP-KAR-A	Cable entry for raised floor tiles, two layers of brushes (opening 410x215 mm)	yes	yes	1 pc





07

SERVICES



**Services**

Test Center for Data Centers (TC4DC)

126

127

# SERVICES

➤ When preparing a complex network project, your consultants, designers and IT department can benefit from the advice and support of our engineers. Our product managers and pre-sales team have in-depth knowledge about the parameters and characteristics of all Conteg product portfolio items, along with technical certificates (Certified Data Center Design Professional, etc.) and years of experience in successfully delivering complex projects. Conteg has an engineered solution to fully meet your requirements, no matter how challenging (or simple) your project may be. Conteg offers services such as pre-assembly of accessories, assembly assistance, cooling unit start-up, training, webinars and personal presentations about our products, along with solutions for both business partners and customers. For more details and pricing information, please contact our Total Solutions Technical Support team or your Area Sales Managers. You can find a list of our services below.

SERVICES	Consulting for Data Center Solutions	Factory Pre-Assembling	Conteg Assembly Assistance	Start-up Service	On-site Product Installation
Data room layout	yes	–	–	–	–
Positioning/arrangement of individual components	yes	–	–	–	–
Energy studies and cooling system projects	yes	–	–	–	–
Project optimization	yes	–	–	–	–
CFD modeling	yes	–	–	–	–
Project documentation check and verification	–	yes	yes	–	yes
Factory installation of accessories	–	yes	–	–	–
Pre-shipment inspection	–	yes	yes	–	yes
Site-readiness check (before installation) and process coordination (during installation)	–	–	–	–	yes
Delivery to site, unpacking, positioning of products	–	–	–	–	yes
Installation of products	–	–	–	–	yes
Final inspection	–	–	yes	–	yes
Commissioning of cooling units	–	–	–	yes	–
User training	–	–	yes	yes	yes
Handover of finished project	–	–	yes	yes	yes



For more information, please contact our sales or technical team at [www.conteg.com/contacts](http://www.conteg.com/contacts)



# TEST CENTER FOR DATA CENTERS (TC4DC)

➤ **Conteg's TestCenter** (in Pelhrimov, Czech Republic) was built for testing the impact of new and existing products on data center power consumption, efficiency, reliability and effectiveness in different configurations. Computer simulations and laboratory measurements allow specialists to verify the principles of various server room processes in order to implement innovative solutions.



## WHAT CAN BE MEASURED?

- Humidity
- Temperature (water, air and surface of all equipment and racks)
- Air- and water-flow
- Speed of various media in pipes and ducts
- Pressure differences (in individual parts of experimental arrangements)
- CO<sub>2</sub> concentration
- Electrical parameters (voltage, current and power consumption)
- Noise parameters
- Rotation (fan or compressor speed)

## DESCRIPTION:

- Total area: 156 square meters

### Consists

- Experimental data center (designed as an actual data center) with raised floor and

suspended ceiling for simulating actual situations

- possibility of installing individual racks, rows, contained aisles and closed-loops
- Rooms for technical support
  - spaces for hardware and software

### Ancillary spaces

- Workshop area for hardware (used in testing) and software (used to examine results)
- Conference room (for team meetings and technical presentations)

# Index

AC-COND2	85	DP-ST5	93	OPW-3016RD-YL	67
ACP-IW	54	DP-S01-VENT	57	OPW-RRB	65, 70
ACP-OW	55	DP-UL	118	OPW-SDMB	68-69
AC-PUHZ	83-84	DP-01-VENT	92	OPW-SRB	70
AC-TCW	82	DP-VEC	88	OPW-TR-16/xx	65, 70, 73
AC-TDS	83	DP-VEL	89	OPW-TRB-16	70
AC-TDX	83	DP-VEN	88-89	OPW-TRB-30	65, 70
AC-TOP2-CW	87	DP-VEN-01	89	OPW-TR-BR	65, 70, 73
AC-TOP3-CW	87	DP-VER	88	OPW-TR-CM	73
AC-TXC	85	DP-VE-ROV2	89	OR	115
AEGIS	103	DP-VE-ROV4	89	ORMS-01	57
CO-BU	21	DP-VE-01	89	ORN	116
CONTAINED AISLE	90	DP-VP-K	75	ORN-M	116
CO-TU	22	DP-VP-M	75	ORN-01	116
CPW-20CA	72	DP-VP-P	74	ORN-02	116
CPW-20CAC-3U	72	DP-VP-PS01	57	ORO	115
CPW-20CAC-0U	72	DP-VP-VR	76	ORPM-01	115
CPW-20-CC	72	DP-VV-xxU/150	77	ORS	57
CPW-20CC-SM	72	DP-VV-A	76	ORVE-01	116
CPW-20CD	72	DP-WALL	122	ORVM-01	116
CPW-20CDC	72	DP-ZA	90	PP	117
CPW-20-EC	72	DP-ZA-2U-110	117	RAMOS	96-101
CPW-20-R	72	DP-ZA-4U-110	117	RAMOS Mini	96, 98-99
CPW-20TAC-3U	72	DP-ZA-S1U	57	RAMOS Optima	96, 98-99
CPW-20TAC-0U	72	DP-ZE	118	RAMOS Plus	96, 98-99
CPW-20TD	71	DP-ZM-CL	118	RAMOS Ultra	96-97, 99
CPW-20TDC	71	DP-ZM-E	101	RAMOS Ultra ACS	96, 100-101
CPW-BR-BR	73	DP-ZM-EML	101	RDF	6, 14-17, 113
CPW-CDB	73	DP-ZM-ES	101	REH	56-57
CPW-ORB	73	HDWM	60-64, 72	REN	50, 53
CPW-RRB	73	HDWM-FDF	61	Ri7	26-31
DP-AFD	91	HDWM-FSS	64	RM7	26, 34-37
DP-BP	92	HDWM-HM	60, 63	RM7-CO	40
DP-DD	114	HDWM-HML-1F	60	RM7-DO	40
DP-DR	121	HDWM-VCT	64, 72	RM7-HVE	37
DP-DSZ	117	HDWM-VMF	60, 62, 64	RM7-SP	40
DP-DSZ-S	57	HDWM-VMF-ACT	64	RM7-TB	40
DP-DU	113	HDWM-VMF-B15	64	RMS	99-102
DP-EHC-1000	47	HDWM-VMF-B25	64	RMS-ACS	100-101
DP-ES	46	HDWM-VMF-BLANK	64	RMS-ACS-CMIF	101
DP-HPR	91	HDWM-VMR-19	64	RMS-ACS-EMT	101
DP-HR	118	HDWM-VMR	60, 62	RMS-ACS-HID	101
DP-KO	122	HDWM-VMR-ACT	64	RMS-ACS-U-RDU	100
DP-KP	72, 123	HVMF	76	RMS-CON-ACS	101
DP-KP-LEM	72, 123	HVMP	76	RMS-CPS	102
DP-MO	121	HVMS-B	77	RMS-I	99
DP-MP-S1U	57	HVMS-CH	77	RMS-U	99
DP-NO	122	HVMS-H-600	76	ROF-CS	25
DP-OJ	123	HVMS-H-800	76	ROF-ES	45-46
DP-PDN	120	HVMS-H-A	76	ROF-LV	47
DP-PO	112	IP-BA	107	ROF-RS	45-46
DP-PO-xxxV	113	IP-C	109	ROP	24
DP-P-PDN	119-120	IP-DEA	108	RS	43
DP-P-PFN	119-120	IP-DEI	107	RSB	6, 18-20
DP-P-PFN-FI	120	IP-DMA	108	RSB-CM	20
DP-PP-S1U	57	IP-DMI	107	RSF	6-11, 93, 113
DP-PR	119	iSEVEN FLEX SERVER	38-40	RSF BYTEline	6, 12-13
DP-PT	112	iSEVEN SERVER	32-33	RSG2	42
DP-PT-S200	57	K-LKD	104	RSG4	41
DP-PV	114	K-SA	104	RSSD-BRACE	44
DP-PZ	112	LES-RACK	105	RSSD-RAIL	44
DP-PZ-xxxV	113	OPW	65-70, 73	RSSD-VP	44
DP-RE	114	OPW-10DRC-YL	68	RUD	50, 52
DP-ROF-CW	91	OPW-10DRFC-YL	68	RUN	50-51
DP-RP	106	OPW-10DRF-TB3	68	STS	93
DP-RP-LC-C3	109	OPW-10DRF-TB30	68	VO-P	74
DP-RP-VM	108	OPW-10DRF-TG	68	VO-W	75
DP-RS	46	OPW-10DRF-YL	68		
DP-RSB-CW	20	OPW-10DR-YL	68		
DP-RSF-CW	91	OPW-10IA45-YL	68		
DP-RSF-CWA	91	OPW-10TP-YL	68-69		
DP-RxF-CW	91	OPW-3016RDC-YL	67		

## outTEG outdoor cabinets

Don't compromise. You can benefit from the advantages offered by the new specialized outTEG line. With a compact design, clear line and climate control system, outTEG satisfies the requirements of customers based in high temperature locations as well as those situated in regions with extremely low temperatures.

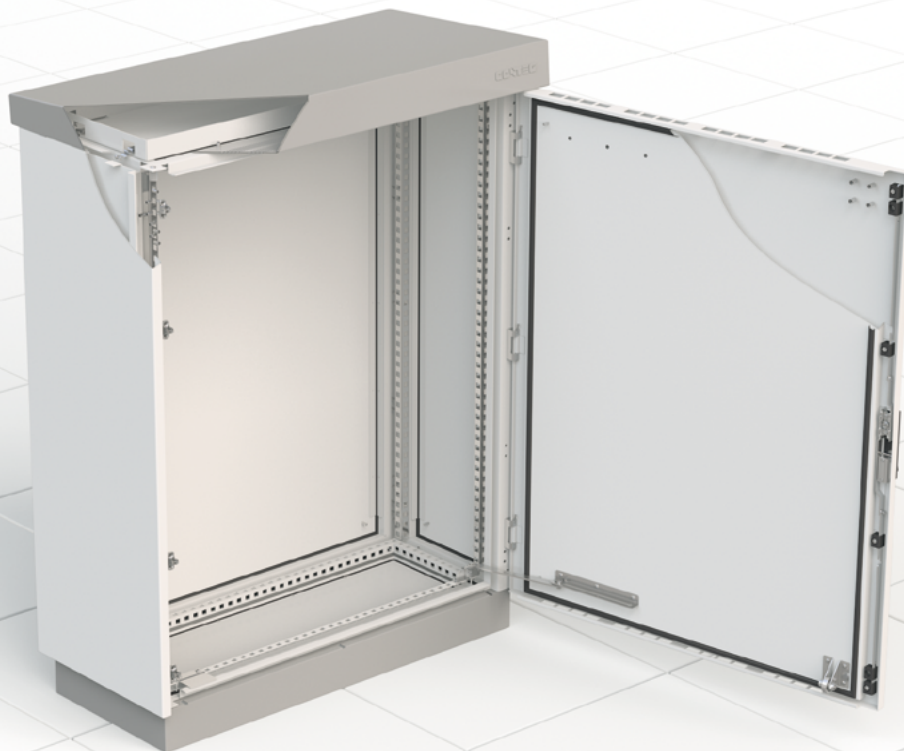

For more information, please contact our sales or technical team at [www.conteg.com/contacts](http://www.conteg.com/contacts) or use our online configurator at [www.conteg.com/configurators](http://www.conteg.com/configurators)



www.conteg.com



**CONTEG, spol. s r.o.**

**Headquarters:**

Na Vítěznej pláni 1719/4  
140 00 Prague 4  
Czech Republic  
Tel.: +420 261 219 182  
conteg@conteg.com  
www.conteg.com

**Production plant:**

K Silu 2179  
393 01 Pelhřimov  
Czech Republic  
Tel.: +420 565 300 300

**Local Branches / Offices:**

Austria / Germany / Switzerland:	+420 261 219 182
Benelux:	+31 76 5420 709
Southeastern Europe:	+49 172 8484 346
Finland:	+358 50 414 1257
France / Italy / Maghreb:	+33 1 60 04 55 90
Middle East / Saudi Arabia	+966 54 000 2341
Russia / CIS:	+7 495 967 3840

Although this catalog was prepared, produced and checked with the best of care, Conteg, spol. s r.o. cannot accept any liability for omissions or errors in this publication. Due to continuous development and progress, Conteg, spol. s r.o. also reserves the right to change the product details and technical specifications shown in this catalog. Such changes, along with eventual errors or printing errata, shall not constitute grounds for compensation.

Your supplier